

CD AUTO CHANGER

KDC-C469/Y/FM/FMA KDC-C669/Y SERVICE MANUAL

KENWOOD

© 2002-11 PRINTED IN JAPAN
B51-7994-00 (N) 3379

The MECHANISM OPERATION is the same as model KDC-C660.
Please refer to the service manual of model KDC-C660 (B51-7105-00).

Service jig	Parts No.
For initial position setting	W05-0635-00

When transporting these models, always attach CAUTION CARD and STEPPED SCREW (for transportation).

Illustration is
KDC-C469/Y.

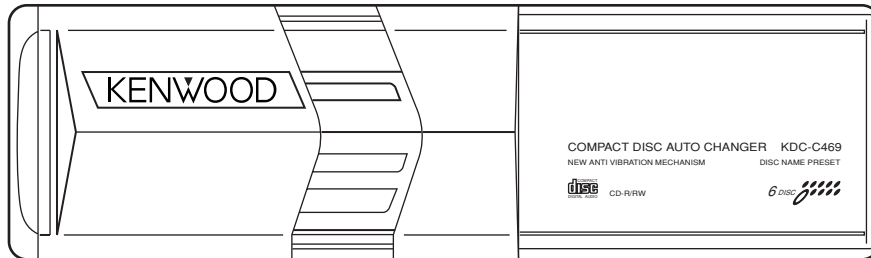

REMOTO
CONTROLLER ASSY
(A70-2032-05)
RC-504FM
: KDC-C469FM/FMA (E)

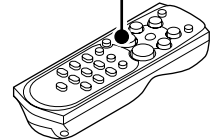
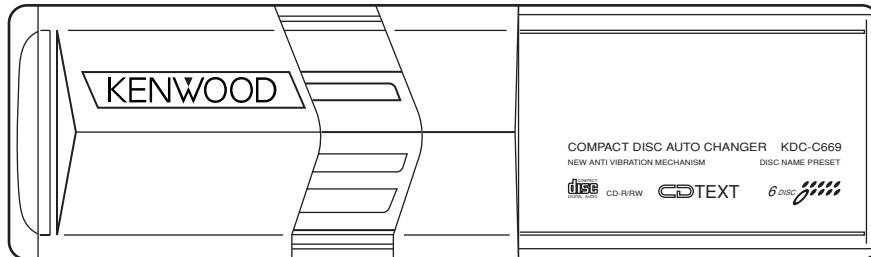

Illustration is
KDC-C669/Y.



HOLDER ASSY
(B07-2138-08)
: KDC-C469FM/FMA

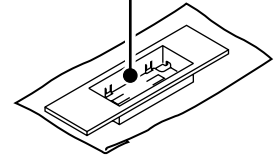
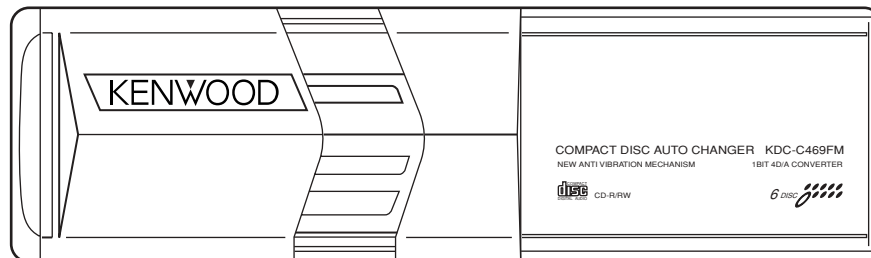

Illustration is
KDC-C469FM/FMA.



BATTERY (SIZE:AAA)
Not supplied as
service parts



DISPLAY UNIT ASSY
(T95-0247-08)
: KDC-C469FM (K)
(T95-0244-08)
: KDC-C469FM (E)
(T95-0251-08)
: KDC-C469FMA (E)

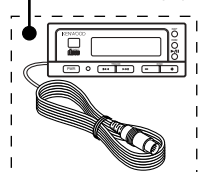

CORD WITH PLUG
(E30-4291-05
or E30-4954-15)

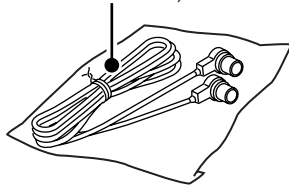

BRACKET (L) BRACKET (R)
(J19-5020-03) (J19-5021-03)

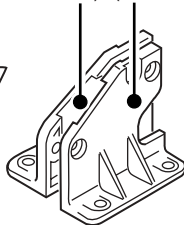

SCREW SET
(N99-1645-15)

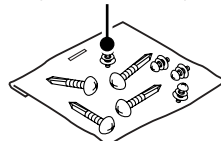

MAGICTAPE ASSY
(W01-0763-08)
: KDC-C469FM/FMA

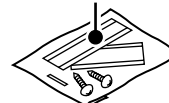

CASE
(A01-2819-08)
: KDC-C469FM (K)
(A01-2824-08)
: KDC-C469FM/FMA (E)

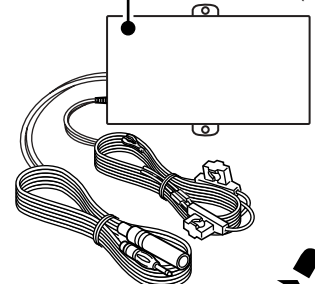

TRAY
(J99-0614-01) HOLDER ASSY
(J19-5149-02)

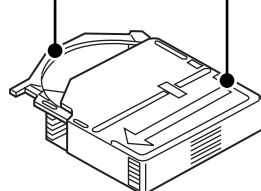

ANTENNA
ADAPTOR
(T90-0521-05)
: KDC-C469FM/FMA (E)



ANTENNA
ADAPTOR
(T90-0512-05)
: KDC-C469FM/FMA (E)



BLOCK DIAGRAM

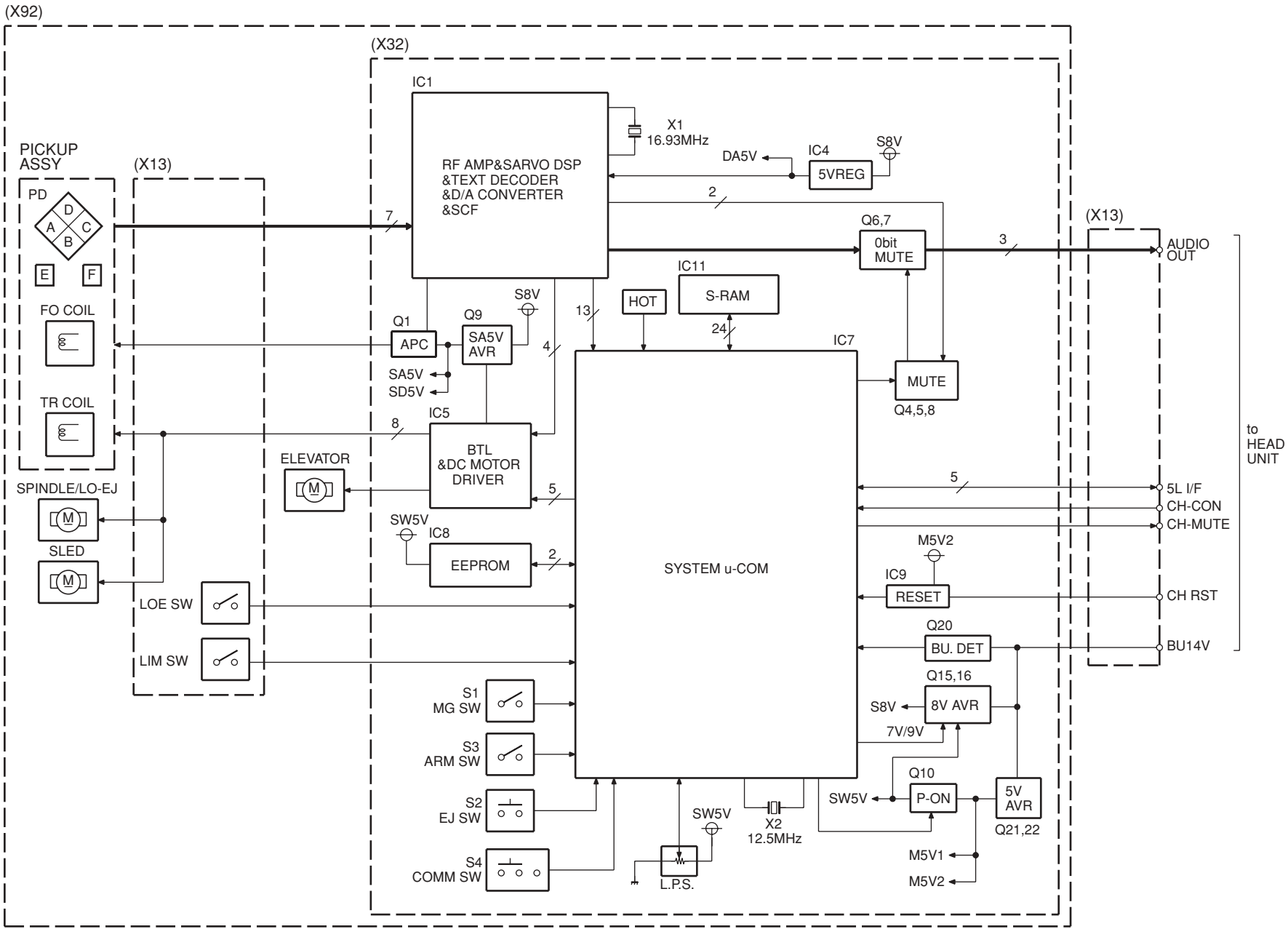

BLOCK DIAGRAM

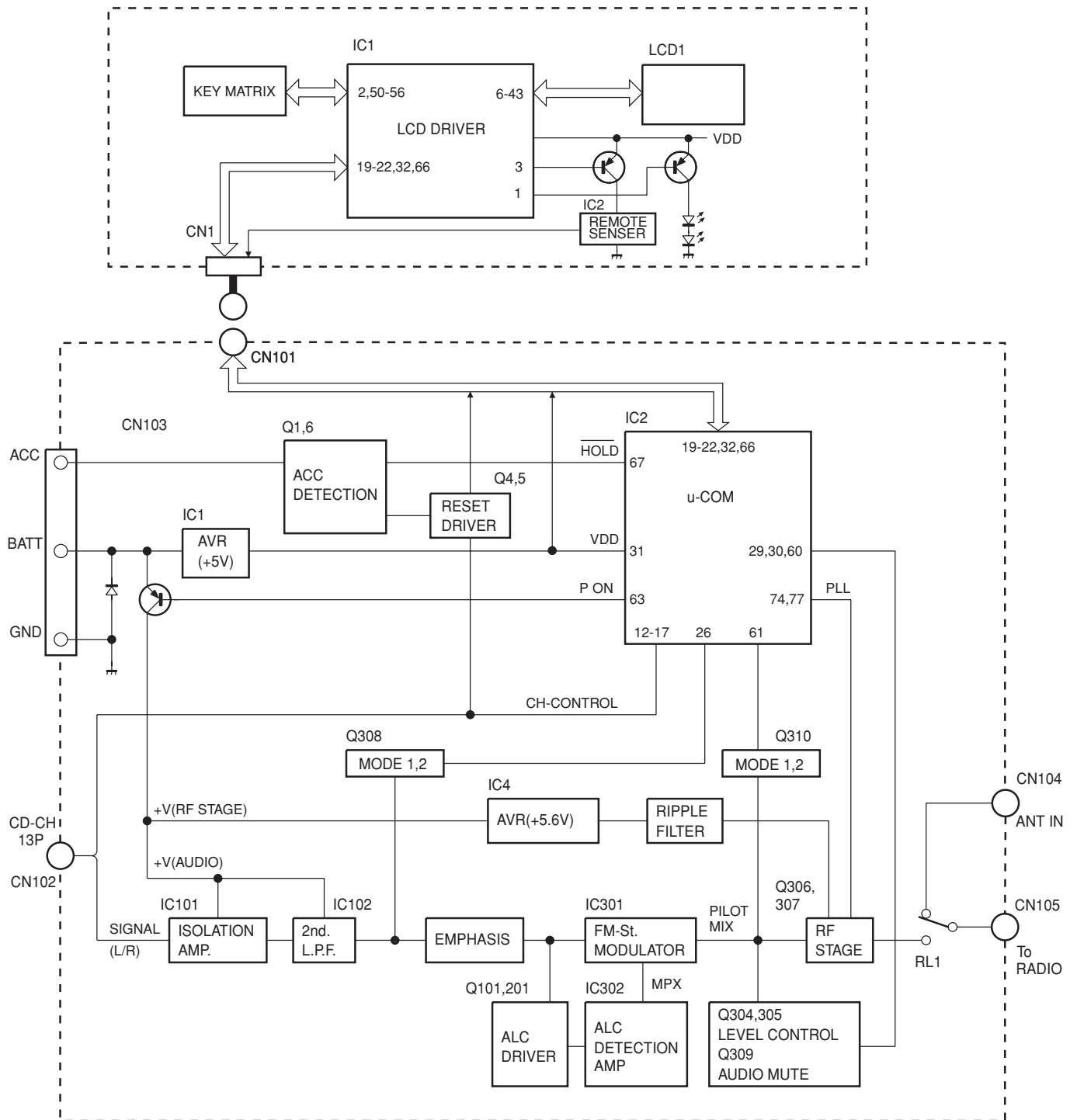

COMPONENT DESCRIPTION

● CD PLAYER UNIT (X32-5470-0x)

Ref. No.	Component Name	Application/Function	Operation/Condition/Compatibility
IC1	UPD63711AGC	Servo IC	RF amplifier built in digital servo and data processor IC. Focusing, tracking, sled and spindle servo processing. Detection of dropout, anti-shock, track crossing and off-track conditions. Automatic adjustment (focusing, tracking, gain, offset and balance) operations. Digital signal processing (DSP, PLL, sub-codes, CD-TEXT decode, CIRC error correction, audio data interpolation) operations.
IC4	KIA78L05F	+5V AVR	Analogue output circuit power supply for D/A converter.
IC5	LA6576	Motor driver	Focusing coil, tracking coil, spindle motor and sled motor driver. VO1~VO4 and VOL outputs ON/OFF function. While MUTE1 goes "Hi", VO1 outputs are turned on. While MUTE2 goes "Hi", VO2~VO4 and VOL outputs are turned on. VIN1 amplifier function (input selection and VREF selection) 1. Input selection. While VIN SW terminal goes "Lo", IC pin 15, 16 and 17 inputs are selected. While VIN SW terminal goes "Hi", IC pin 15, 18 and 19 inputs are selected. 2. VREF selection. While VIN SW terminal goes "Lo", internal VREF (2.5V typical) is selected. While VIN SW terminal goes "Hi", external VREF (IC pin 30 input) is selected.
IC7	UPD784214GC098	Mechanism MI-COM.	Mechanism and servo control.
IC8	BR24C02F-W	EEPROM	LPS data back-up memory.
IC9	S-80830CNNP	Reset IC	When BU 5V voltage is less than 3.0V, IC outputs "Lo".
IC11	LC3564BT-70	S RAM	CD-TEXT data memory.
Q1	MCH6101	APC	Laser diode auto power control.
Q4	DTA124EK	0 bit mute (L CH.)	When 0 bit mute is activated, an emitter goes "Hi", and Q4 outputs "Hi".
Q5	DTA124EUA	0 bit mute (R CH.)	When 0 bit mute is activated, an emitter goes "Hi", and Q5 outputs "Hi".
Q6	DTC343TK	Mute SW (L CH.)	When 0 bit mute or A mute drive is activated, a base goes "Hi", and L channel audio signal is muted.
Q7	DTC343TK	Mute SW (R CH.)	When 0 bit mute or A mute drive is activated, a base goes "Hi", and R channel audio signal is muted.
Q8	DTA124EK	A mute drive	When audio mute of IC7 is activated, a base goes "Lo", and audio mute drive signal is outputted.
Q9	2SB1202	Servo 5V AVR	Q9 is combined with IC5's pin 26 and 27, and works as a driver of AVR.
Q10	2SB1295	P-ON 5V SW	While base goes "Lo", P-ON 5V is supplied to the microprocessor peripheral circuits.
Q11	DTC124EK	Reset SW	When System Reset has activated, a base goes "Hi", and Q11 is turned on.
Q13	DTC124EUA	CH CON SW	While CH CON or CH-CON2 mode is selected, a base goes "Hi", and Q13 is turned on.
Q14	DTA143EUA	CH MUTE SW	When MUTE REQUEST to H/U is outputted, a base goes "Lo", and Q14 is turned on.
Q16	2SC4081	SRV 8V AVR	Q16 is combined with Q15 (X92-), and works as a pre-driver of AVR.
Q17	DTA143EK	SRV 8V AVR SW	When Q18's base goes "Hi", Q17 is turned on, and SVR 8V AVR is working.
Q18	DTC124EUA		
Q19	DTC124EUA	7/9V SW	When a base goes "Hi", Q19 is turned on, and SVR 8V AVR is outputting +7V. When a base goes "Lo", Q19 is turned off, and SVR 8V AVR is outputting +8.5V.
Q20	DTC124EK	BU DETECTION SW	While BACKUP is applied, a base goes "Hi", and Q20 is turned on. When momentary power down has detected, a base goes "Lo", and Q20 is turned off.
Q21	2SB1202	BU 5V AVR	While BACKUP is applied, AVR outputs +5V. Q21 and Q22 are inverted Darlington connection.
Q22	2SC4081		

COMPONENT DESCRIPTION

Ref. No.	Component Name	Application/Function	Operation/Condition/Compatibility
Q30	DTC114YUA	Eccentric disc SW	When an eccentric disc is detected, Q30 is turned on, and a preceding beam is made to be delayed.
Q31	DTC124EUA	VIN SW	While spindle servo or disc loading/eject mode is selected, a base goes "Hi", and Q31 is turned on.

● RF MODULATOR UNIT

Ref. No.	Component Name	Application/Function	Operation/Condition/Compatibility
IC1	UPC7805AHF	BU 5V AVR	While BACKUP is applied, AVR outputs +5V.
IC2	LC72329-9B24	System MI-COM.	System control.
IC4	NJM78L05UA	5V AVR	Power supply for FM modulator and RF amplifier.
IC101	NJM2060M	Isolation amp.	
IC102	NJM4565MD	Low pass filter	
IC301	BA1405F	FM ST modulator	
IC302	NJM4565MD	1/2 VCC driver, ALC detection amp.	
Q1	DTC124EK	ACC detection	When Q4 is turned on, Q1 is turned on during ACC applied.
Q2	2SA1782(T,U)	POWER SW	When Q3's base goes "Hi", Q2 is turned on, and RF modulator circuit is working.
Q3	DTC124EK		
Q4	DTC143TK	Reset SW	When RESET SW on display unit is pressed, Q4, Q1 and Q6 are turned off, and IC2 is holding.
Q5	DTC143TK	CH RESET SW	When RESET SW on display unit is pressed, Q5 is turned off, and SYSTEM RESET signal is outputted to CD changer.
Q6	DTA124EK	Hold detection SW	When RESET SW on display unit is pressed or ACC is OFF, Q6 is turned off, and IC2 is holding.
Q8	DTC143TK	Relay driver	FM modulator output / Vehicles antenna input switching. When a base goes "Hi", FM modulator output is selected.
Q9	2SC4640(T,U)	Ripple filter	Power supply for RF amplifier
Q101	2SK2158	ALC control SW	
Q201	2SK2158		
Q303	2SA1162(GR)	Pilot mix amp.	
Q304	2SK2158	Level control SW	Level 1/2 : OFF, Level 3/4 : ON
Q305	2SK2158	Level control SW	Level 2/4 : OFF, Level 1/3 : ON
Q306	2SK508L	RF oscillator buffer	
Q307	2SC2714(Y)	RF amp.	
Q308	2SK2158	Mode (1/2) SW	Mode 1 : ON, Mode 2 : OFF
Q309	2SK2158	Audio mute	POWER ON mode : OFF, POWER OFF mode : ON
Q310	2SK2158	Mode (1/2) SW	Mode 1 : OFF, Mode 2 : ON

● DISPLAY UNIT

Ref. No.	Component Name	Application/Function	Operation/Condition/Compatibility
IC1	LC75852W	LCD driver with key-matrix	
IC2	PNA4602M	Remote control light sensor	
Q1	DTC144EK	LED ON/OFF SW	When Q1's base goes "Hi", Q2 is turned on, and LED is turned on.
Q2	DTB123YK		
Q3	DTA144EK	Key-matrix permission SW	Ready on key-matrix
Q4	DTC144EK	IC2 ON/OFF SW	When Q4's base goes "Hi", Q5 is turned on, and 5V is supplied to remote control sensor.
Q5	DTA144EK		

MICROCOMPUTER'S TERMINAL DESCRIPTION

● Mechanism Microcomputer : UPD784214GC098 (X32- : IC7)

Pin No.	Pin Name	I/O	Description	Processing Operation
1	NOR/RW	O	CD-DA/CD-RW Switching	Not used (N.C.)
2	$\overline{\text{TSTB}}$	O	CD-TEXT parameter strobe	
3	P-CON	O	P-CON output	Not used (N.C.)
4	FOK	I	Focus OK input	"Hi" : Focus OK
5	$\overline{\text{XTALEN}}$	O	Servo IC oscillation stop control	"Hi" : Oscillation stop
6	RST	O	Servo IC reset terminal	"Lo" : Reset
7	SAO	O	Servo IC command/parameter setting terminal	"Hi" : Parameter setting, "Lo" : Address register setting
8	SSTB	O	Servo IC command/parameter setting strobe terminal	"Hi"→"Lo" : Serial data latch
9	VDD	-	Positive power supply connection terminal	Connected to D 5V lines
10	X2	-	Main clock resonator connection terminal 2	
11	X1	I	Main clock resonator connection terminal 1	
12	VSS	-	Ground connection terminal	Connected to GND lines
13	XT2	-	Sub clock resonator connection terminal 2	Not used (N.C.)
14	XT1	I	Sub clock resonator connection terminal 1	Not used (connected to GND lines)
15	RESET	I	System reset input	"Lo" : System reset
16	FOGUP	I	Vibration detect input	"Hi" : Vibration detect
17	MGSW	I	Magazine switch input	"Hi" : Magazine in
18	EJSW	I	Eject switch input	"Hi" : Eject switch ON
19	COMMSW	I	5-line communication old/new switch input	"Hi" : New communication, "Lo" : Old communication
20	PACK	I	Text data pack synchronous signal input	"Hi"→"Lo" : The head of the pack data
21	CH-CON	I	Changer control input	"Hi" : Standby mode, "Lo" : Operation mode
22	BUDET	I	Momentary power down detection input	"Hi" : When momentary power down detected or BU OFF "Lo" : BU ON
23	AVDD	-	A/D converter positive power supply connection terminal	Connected to D 5V lines
24	AVREF0	I	A/D converter reference voltage input	Connected to PON 5V lines
25	HOT	I	Rise in temperature detection input	
26	LPS	I	LPS Mechanical deck position detection input	
27	LOESW	I	Loading complete switch input	"Lo" : Loading complete
28	LIMSW	I	Limit switch input	"Lo" : Pickup most inner position
29	TOFF	I	Tracking OFF mode terminal	Not used (pull down to GND lines)
30	ADJSEL	I	Servo automatic adjustment ON/OFF terminal	Not used (pull down to GND lines)
31	TBANK	I	Tracking gain switching mode terminal	Not used (pull down to GND lines)
32	SIM2	I	Destination input 2	Not used (pull down to GND lines)
33	AVSS	-	A/D, D/A converter ground connection terminal	Connected to GND lines
34	LPSCO	O	LPS A/D converter reference power control output	Not used (N.C.)
35	AMUTE	O	Audio mute output	"Lo" : Audio mute ON
36	AVREF1	I	D/A converter reference voltage input	Connected to D 5V lines
37	SDI	I	Servo IC communication serial data input	
38	SDO	O	Servo IC communication serial data output	
39	SCK	O	Servo IC communication serial clock output	
40	DATAH	I	Data input from H/U	
41	DATAO	O	Data output from the changer	
42	HCLK	I/O	Communication clock input/output with H/U	
43	RECQC	O	Communication request to H/U	"Lo" : Communication requested
44	CHMUTE	O	Audio mute request to H/U	"Lo" : Audio mute requested

MICROCOMPUTER'S TERMINAL DESCRIPTION

Pin No.	Pin Name	I/O	Description	Processing Operation
45	TSI	I	Text data input from servo IC	
46	TSO	O	Text data output to servo IC	
47	$\overline{\text{TSCK}}$	O	Text data clock to servo IC	
48~55	A0~A7	O	Address setting terminal for S RAM	
56~63	D0~D7	I/O	Data input/output terminal with S RAM	
64~68	A8~A12	O	Address setting terminal for S RAM	
69~71	A13~A15	O	Chip enable setting terminal for S RAM	Not used (pull down to GND lines)
72	VSS	-	Ground connection terminal	Connected to GND lines
73	A16	O	Chip enable setting terminal for S RAM	Not used (pull down to GND lines)
74	A17	O	Chip enable setting terminal for S RAM	
75	RAMOK	O	Pickup check judging terminal for production	Not used (N.C.)
76	ELVADJ	I	Mechanism deck ascent/descent position terminal	Not used (pull up to D 5V lines)
77	RD	O	Read-out to S RAM control output	
78	WR	O	Write to S RAM control output	
79	WAIT	I	Waiting time insertion input when accessing S RAM	Not used (pull down to GND lines)
80	ASTB	O	Chip selection to S RAM	Not used (N.C.)
81	VDD	-	Positive power supply connection terminal	Connected to D 5V lines
82	PUSEL	I	Pickup type select terminal	Pull up to D 5V lines
83	REQH	I	Communication request from H/U	"Lo" : Communication requested
84	SPLO+	O	Spindle/Loading control terminal	
85	SPLO-	O	Spindle/Loading control terminal	
86	ELV+	O	Mechanism deck ascent/descent terminal	
87	ELV-	O	Mechanism deck ascent/descent terminal	
88	SIM1	I	Destination input 1	"Lo" : adapted for CD-TEXT, "Hi" : not adapted for CD-TEXT
89	SEARCH	O	Search mode output	Not used (N.C.)
90	TEST1	I	Test mode terminal 1 for test mode	Not used (pull down to GND lines)
91	TEST2	I	Test mode terminal 2 for test mode	Not used (pull down to GND lines)
92	8/7V	O	Motor driver IC power voltage control output	"Hi" : 7V, "Lo" : 8.5V
93	EEPWR	I	EEPROM write mode terminal for production	Not used (pull down to GND lines)
94	TEST/VPP	I	Flash ROM program mode terminal	Not used (connected to GND lines)
95	SRVSEL	I	Servo active mode terminal (no mechanism movement)	Not used (pull down to GND lines)
96	SLNSA	I	Sled non-sensitive area ON/OFF terminal	Not used (pull down to GND lines)
97	SDA	I/O	Data input/output with EEPROM	
98	SCL	O	Clock output to EEPROM	
99	PON	O	PON output	"Lo" : AVR & LPS POWER ON
100	ARMSW	I	Arm switch input	"Hi" : Arm switch ON

● System Microcomputer : LC72329-9B24 (RF Modulator Unit : IC2)

Pin No.	Pin Name	I/O	Description	Processing Operation
1	XIN	I	Main clock resonator connection terminal	
2	TEST2	I	Test mode terminal 2 for test mode	Not used (pull down to GND lines)
3, 4	PG3, PG2	I		Not used (pull down to GND lines)
5	PG1	I		Not used (pull up to +5V lines)
6	PG0	I		Not used (pull down to GND lines)
7~9	PH3~PH1	O		Not used (pull down to GND lines)
10	PH0 MUTE1	O		Not used (N.C.)

MICROCOMPUTER'S TERMINAL DESCRIPTION

Pin No.	Pin Name	I/O	Description	Processing Operation
11	PF3 MUTE0	O		Not used (N.C.)
12	PF2 REQ \bar{C}	I	Communication request input form CH	"Lo" : Communication requested
13	PF1 REQ \bar{H}	O	Communication request output to CH	"Lo" : Communication requested
14	PF0 CHCON	O	Control output to CH	"Hi" : Operation mode, "Lo" : Standby mode
15	PE3 DATA IN	I	Data input from CH	
16	PE2 DATA OUT	O	Data output to CH	
17	PE1 SCK	O	Clock output to CH	
18	PE0	O		Not used (N.C.)
19	PD3 DATA OUT	O	Data output to LCD	
20	PD2 CLK	O	Clock output to LCD	
21	PD1 RST	O	Reset output to LCD	"Lo" : Reset
22	PD0 CE	O	CE output to LCD	
23~25	PC3~PC1			Not used (N.C.)
26	PC0 SEPA	O	Separation select output	"Hi" : Mode 1, "Lo" : Mode 2
27, 28	PB3, PB2	O		Not used (N.C.)
29	PB1 GAIN1	O	GAIN1 output	"Hi" : Level 1/3, "Lo" : Level 2/4
30	PB0 GAIN2	O	GAIN2 output	"Hi" : Level 3/4, "Lo" : Level 1/2
31	VDD +5V	-	Positive power supply connection terminal	Connected to +5V lines.
32	PA3 DATA IN	I	Data input from LCD	
33~35	PA2~PA0	I		Not used (connected to GND lines)
36	PI31 S28	O		Not used (N.C.)
37	PI21 S27	O		Not used (N.C.)
38	PI11 S26	O		Not used (N.C.)
39	PI01 S25	O		Not used (N.C.)
40~58	S24~S6	O		Not used (N.C.)
59	ALC LOW S5	O		Not used (N.C.)
60	MUTE S4	O	Mute output	"Hi" : POWER OFF mode, "Lo" : POWER ON mode
61	SEP ATT S3	O	Separation attenuator output	"Hi" : Mode 2, "Lo" : Mode 1
62	RELAY S2	O	Relay SW control	"Hi" : RF modular output, "Lo" : Vehicle antenna output
63	P ON S1	O	P ON output	"Hi" : RF modulator circuit is active
64,65	COM2, COM1	O		Not used (N.C.)
66	REMO INT \bar{I}	I	Remote control sensor input	
67	HOLD	I	Hold input	"Lo" : Microprocessor stop
68	RES	I		Not used (pull up to +5V lines)
69	AOI	I		Not used (pull down to GND lines)
70	HCTR	I		Not used (pull down to GND lines)
71	LCTR	I		Not used (pull down to GND lines)
72	SNS	I		Not used (pull down to GND lines)
73	VDD	-	Positive power supply connection terminal	Connected to +5V lines
74	FMIN	I	FM input	
75	AMIN	I	AM input	Not used (pull down to GND lines)
76	VSS	-	Ground connection terminal	Connected to GND lines
77	EO1	O	FM frequency control output	
78	EO2	O		Not used (N.C.)
79	TEST1	I	Test mode terminal 1 for test mode	Not used (pull down to GND lines)
80	XOUT	-	Main clock resonator connection terminal	

ADJUSTMENT

● RF MODULATOR UNIT

1. DC balance adjustment (VR301)

While observing the waveform with an oscilloscope at pin 13 of IC301, adjust VR301 to minimize the waveform level.

2. PLL control voltage adjustment (VC301)

First set the transmission frequency to *87.9MHz with the commander, then adjust VC301 so that the DC Voltage at the + pole of C317, measured using a multi-meter or digital tester, is $+3V \pm 0.1V$.

* NOTE : E type is 87.7MHz.

3. Modulation level adjustment (VR303)

The method uses a standard receiver or tuner.

Adjust VR303 so that the output level from the standard receiver or tuner is as specified.

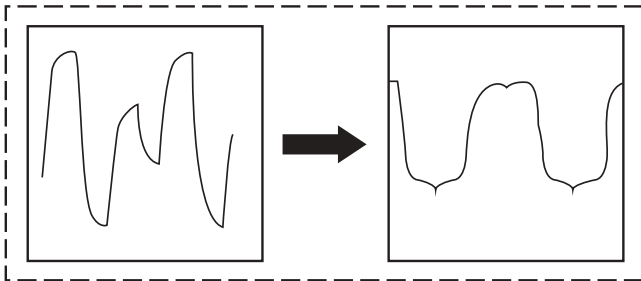

● L.P.S. initial position adjustment procedure

1. Connect the changer to the HEAD UNIT (H/U).

2. While holding the magazine eject button of the changer, press the reset button of the H/U.

3. After about 3 seconds, release the magazine eject button.

4. Press the SRC button of the H/U to enter the CD-CH mode, and the H/U's display section indicates "E-88".

5. Move the mechanism deck to around the 1st stage by pressing the DISC- or DISC+ button.

6. Insert the adjustment tool (W05-0635-00) into the tool hole on the changer mechanism.

7. Then press the DISC+ button to move the mechanism deck until the mechanism's slider hits the adjustment tool.

8. When the motor locks (stops), press the REPEAT key of the H/U.

When the REPEAT key is pressed, the mechanism moves automatically to the 1st stage and the initial position adjustment completes. (The data is written in the EEPROM at this time.)

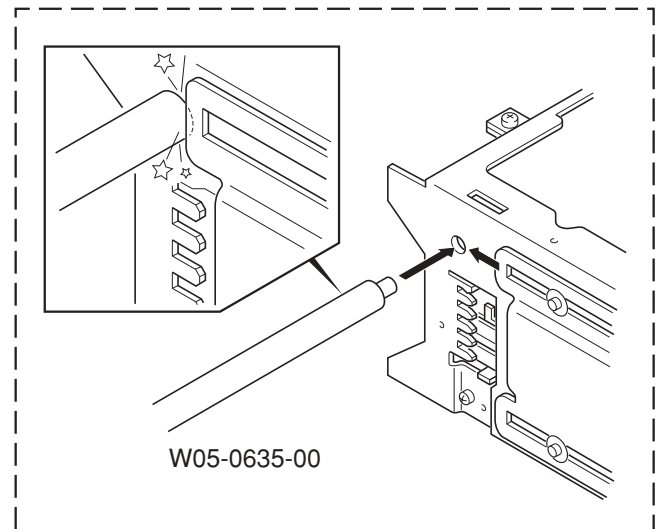

● Caution : Note on IC8 (EEPROM)

Be sure to use the W05-0869-00 when replacing the EEPROM. IC8 stores the digital servo data of the pickup servo.

Therefore, if the EEPROM does not store servo data, ERROR76 (E-76) will indicate the H/U's display section at the moment CD is played.

PC BOARD (COMPONENT SIDE VIEW)

X32-5470-0x (J74-1527-01)

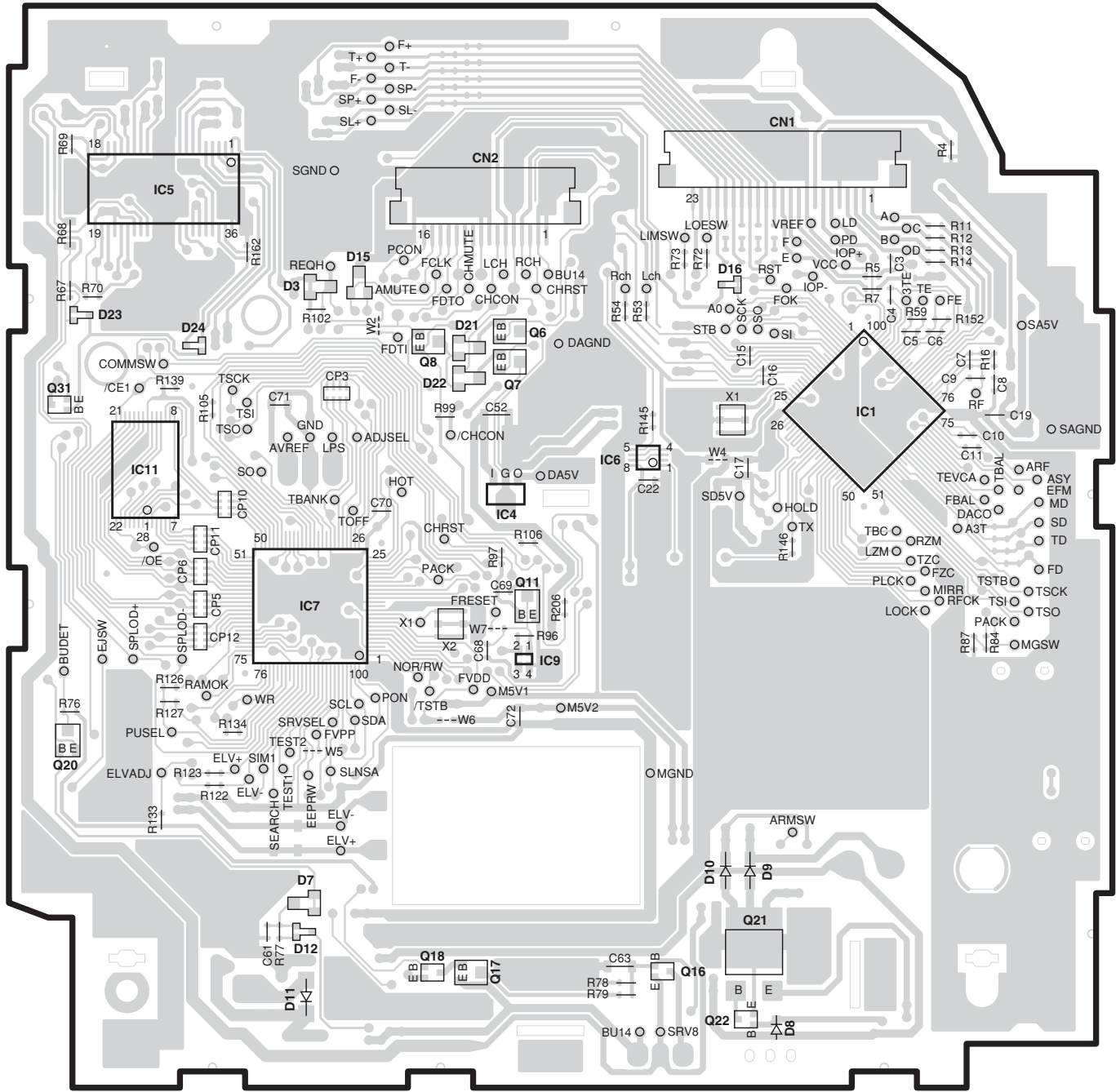

X32-5470-0x

IC	Q	Address	IC	Q	Address	IC	Q	Address
1		3D	6		3C	18		5C
4		3C	7		3C	20		4A
5		2B	8		3C	21		5D
7		4B	11		4C	22		5D
9		4C	16		5D	31		3A
11		3A	17		5C			

Refer to the schematic diagram for the values of resistors and capacitors.

PC BOARD (FOIL SIDE VIEW)

X32-5470-0x (J74-1527-01)

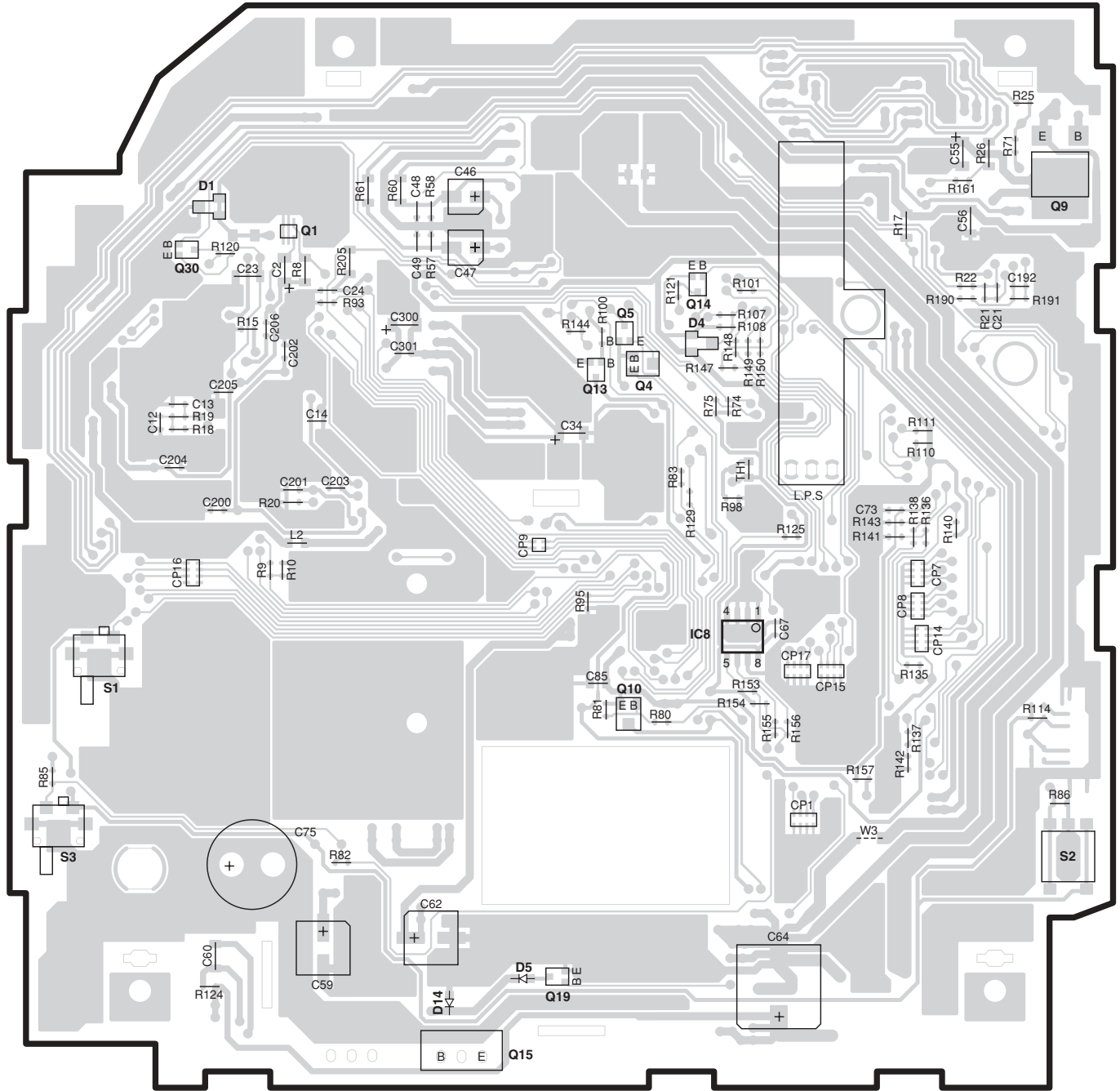

X32-5470-0x

IC	Q	Address	IC	Q	Address
8		4H	10		4H
	1	2G	13		3H
	4	3H	14		3H
	5	3H	19		5H
	9	2J	30		2F

Refer to the schematic diagram for the values of resistors and capacitors.

PC BOARD

(COMPONENT SIDE VIEW)

X13-9840-00 (J74-1100-02)

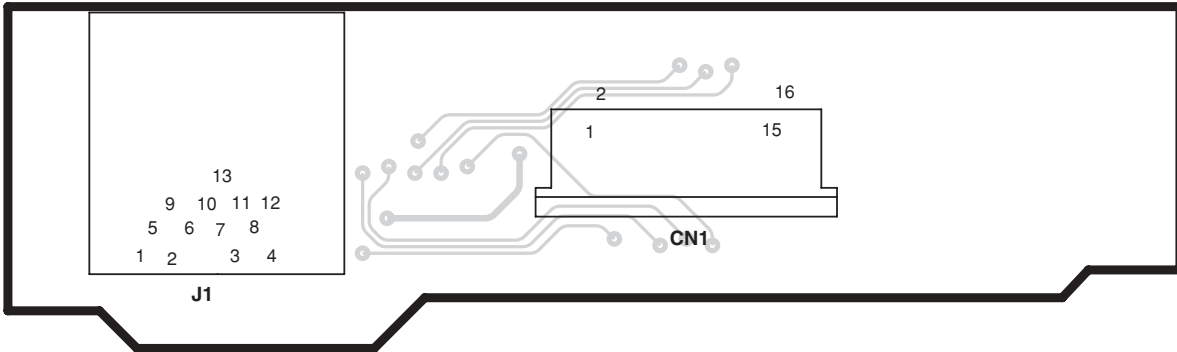

(FOIL SIDE VIEW)

X13-9840-00 (J74-1100-02)

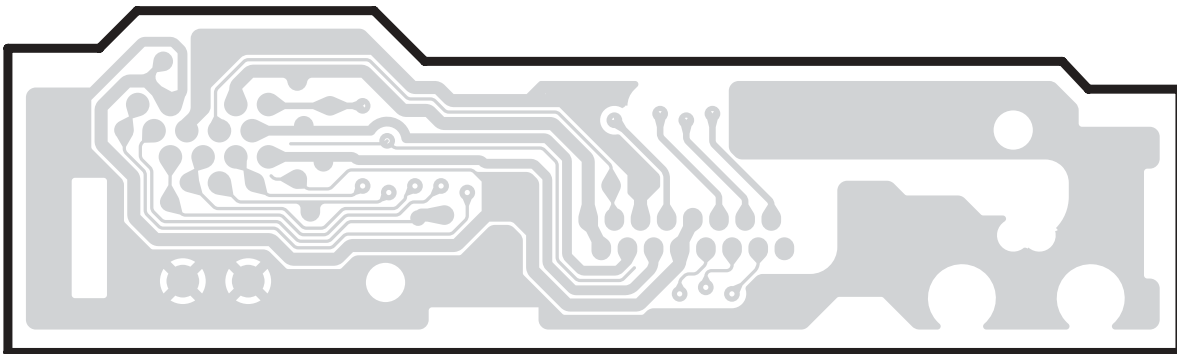

(COMPONENT SIDE VIEW)

X16-1010-00 (J74-1153-01)

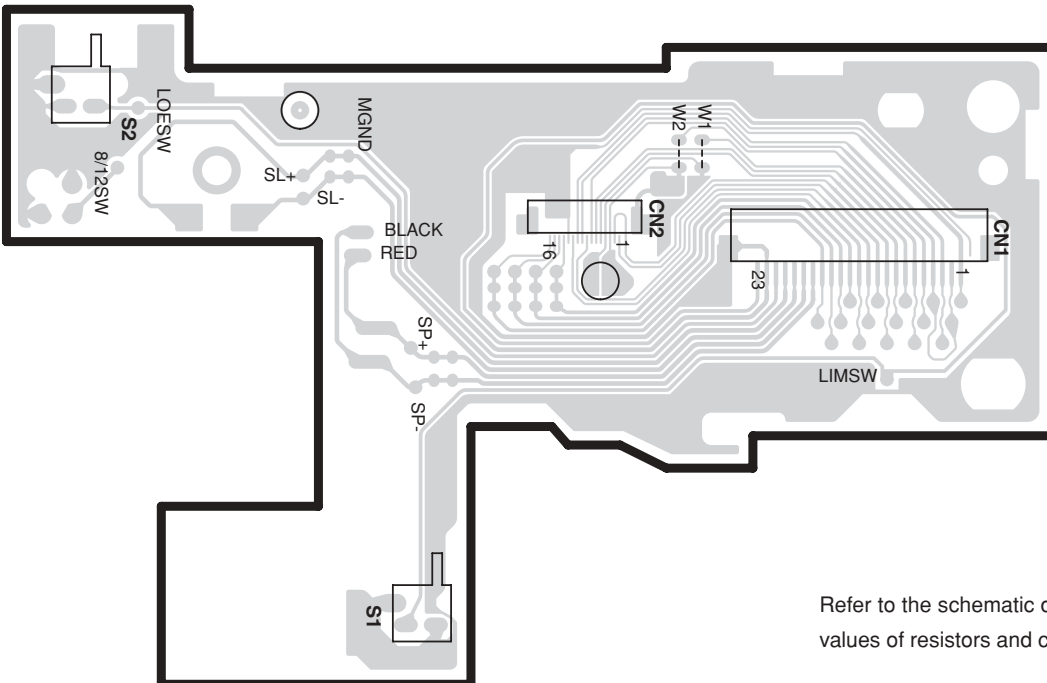

Refer to the schematic diagram for the values of resistors and capacitors.

PC BOARD (FOIL SIDE VIEW)

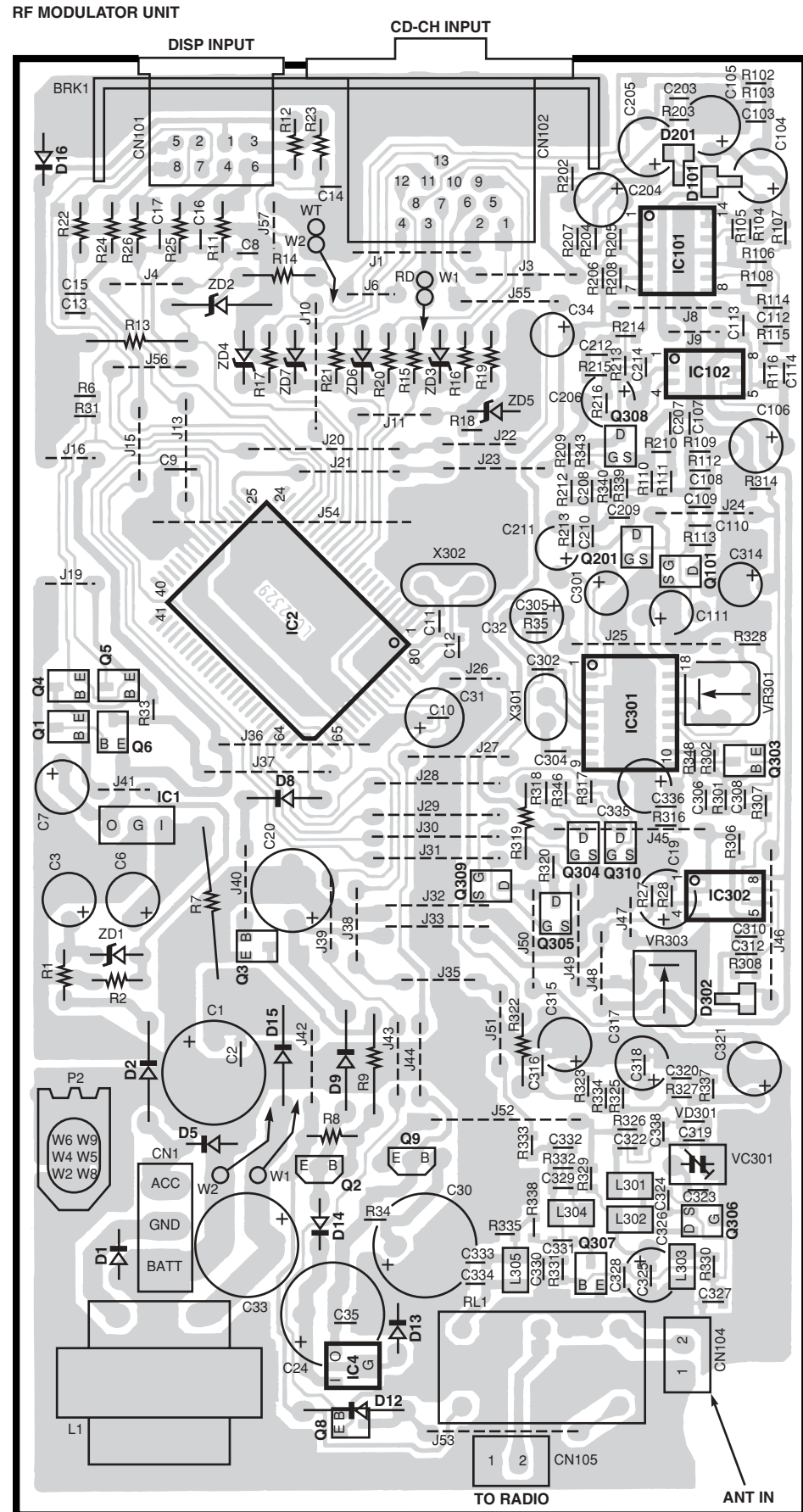

RF MODULATOR UNIT

IC	Q	Address
1		4P
2		4Q
4		7Q
101		2S
102		3S
301		4R
302		5S
	1	4P
	2	6Q
	3	5Q
	4	4P
	5	4P
	6	4P
	8	7Q
	9	6Q
101		3S
201		3R
303		4S
304		5R
305		5R
306		6S
307		6R
308		3R
309		5R
310		5R

(COMPONENT SIDE VIEW)

DISPLAY UNIT

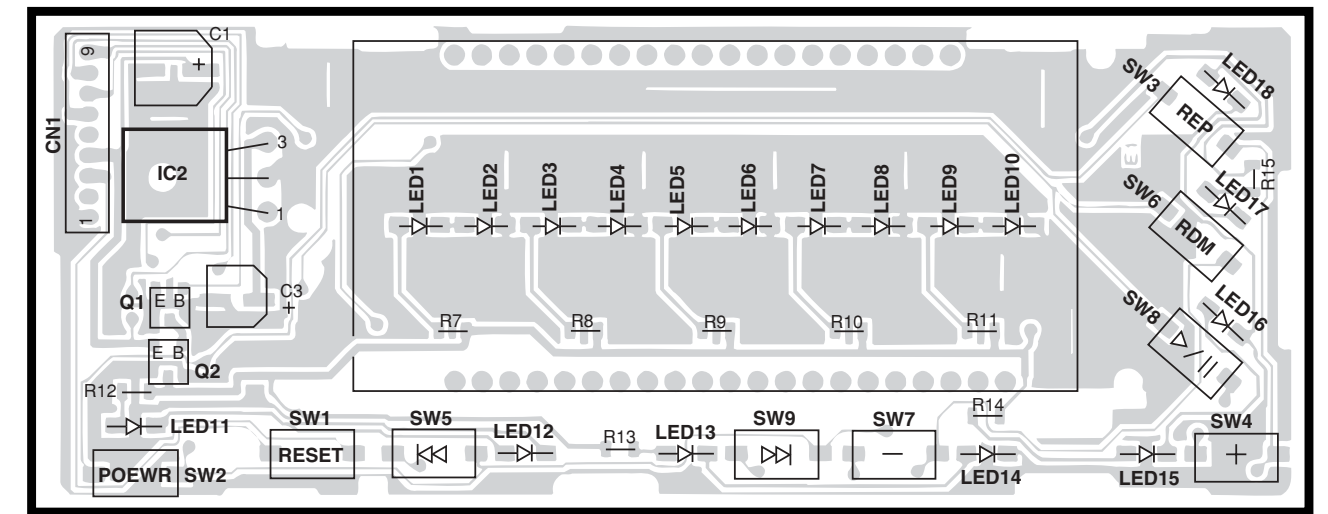

DISPLAY UNIT

IC	Q	Address
2		2U
	1	2U
	2	2U

(FOIL SIDE VIEW)

DISPLAY UNIT

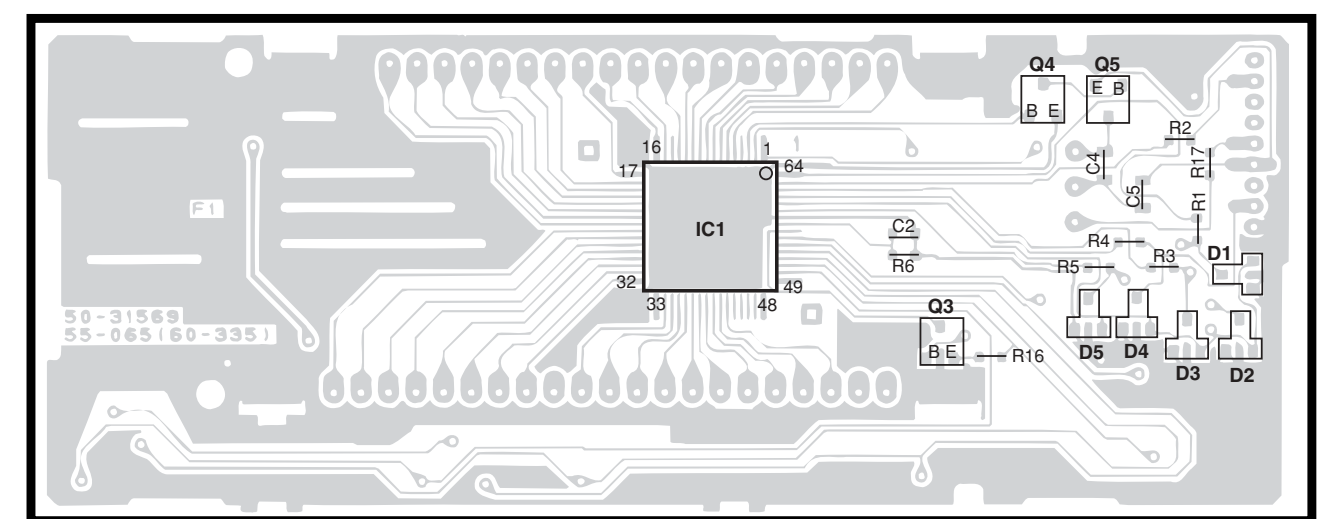

DISPLAY UNIT

IC	Q	Address
1		5W
	3	5X
	4	4X
	5	4X

Refer to the schematic diagram for the values of resistors and capacitors.

CD PLAYER UNIT (X32-5470-0X)

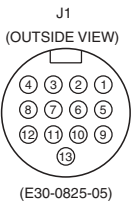
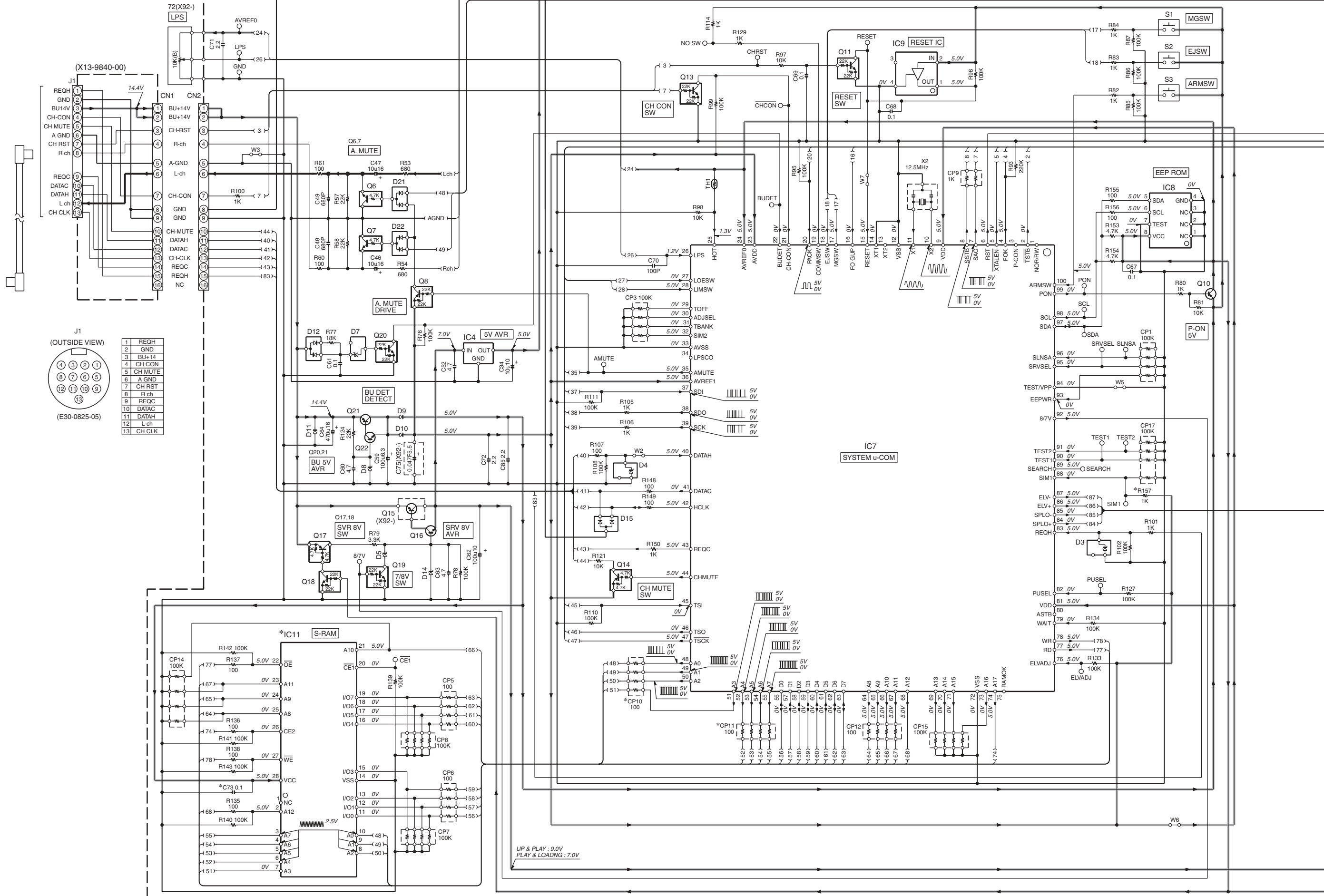

1	REQH
2	GND
3	BU+14
4	CH CON
5	CH MUTE
6	A GND
7	CH RST
8	R ch
9	REQC
10	DATAH
11	DATAH
12	L ch
13	CH CLK

UP & PLAY : 9.0V
PLAY & LOADING : 7.0V

MODEL NAME	C103, 203	C108, 208	R308
KDC-C469FM(K)	0.01	1000P	150K
KDC-C519FM(K,M)			
KDC-C469FM(E)	4700P	680P	120K
KDC-C469FMA(E)			
KDC-C520FM(J)			

- IC1 : UPC7805AHF
 IC2 : LC72329-9B24
 IC4 : NJM78L05UA
 IC101 : NJM2060M
 IC102,302 : NJM4565MD
 IC301 : BA1405F
- D1,5,14 : DSK10C-ET1
 D2,15 : DSK10C-BT
 D8,9,12,13,16 : 1SS131
 D101,201,302 : DA204K
 VD301 : HVU306A-3
 ZD1-7 : MTZ6.2J(B)

- Q1,3 : DTC124EK
 Q2 : 2SA1782(T,U)
 Q4,5,8 : DTC143TK
 Q6 : DTA124EK
 Q9 : 2SC4640(T,U)
 Q101,201,304,305,308-310 : 2SK2158
 Q303 : 2SA1162(GR)
 Q306 : 2SK508L
 Q307 : 2SC2714(Y)



RF MODULATOR UNIT

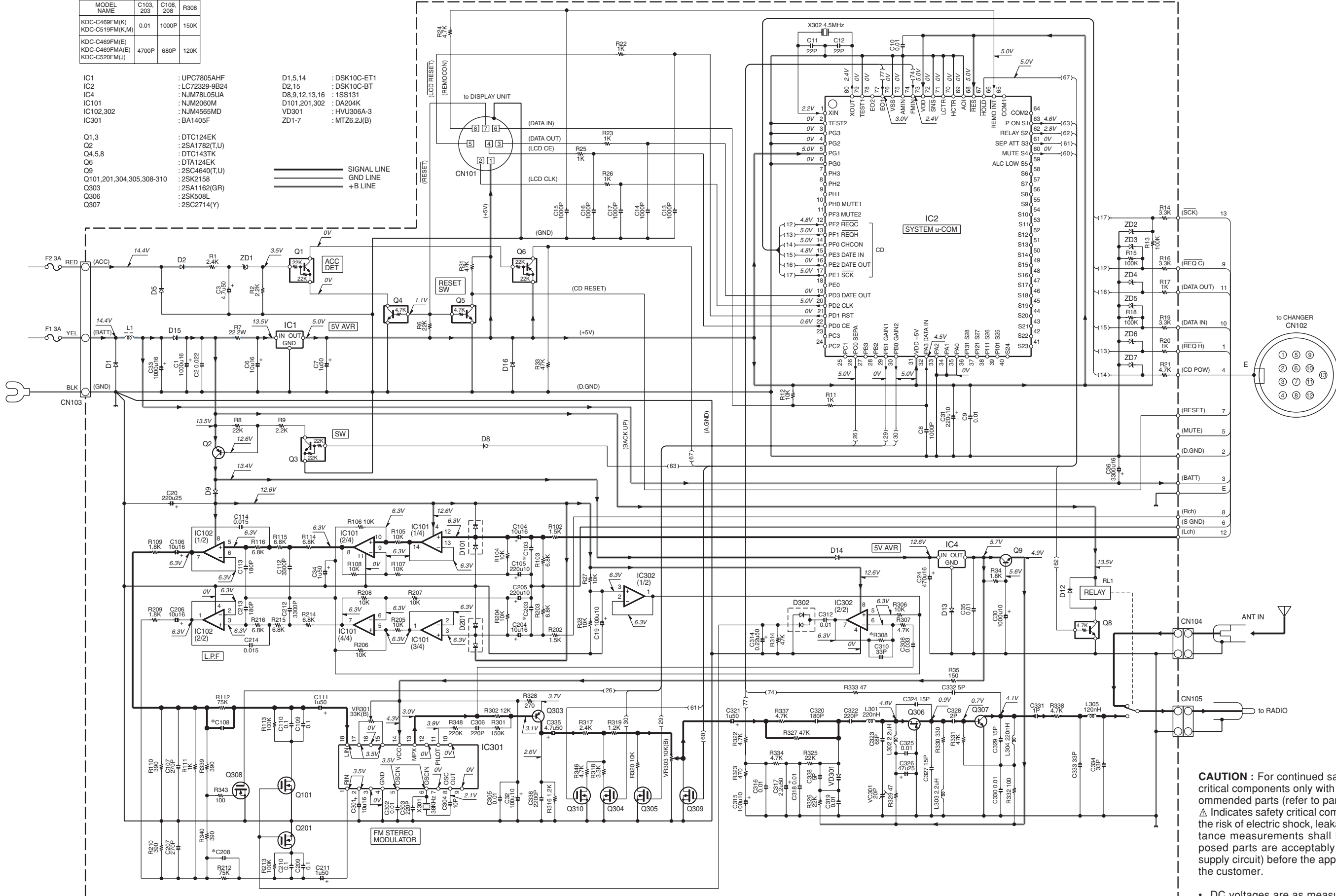

CAUTION : For continued safety, replace safety critical components only with manufacturer's recommended parts (refer to parts list).
 ⚠ Indicates safety critical components. To reduce the risk of electric shock, leakage-current or resistance measurements shall be carried out (exposed parts are acceptably insulated from the supply circuit) before the appliance is returned to the customer.

• DC voltages are as measured with a high impedance voltmeter. Values may vary slightly due to variations between individual instruments or/and units.

1
2
3
4
5
6
7

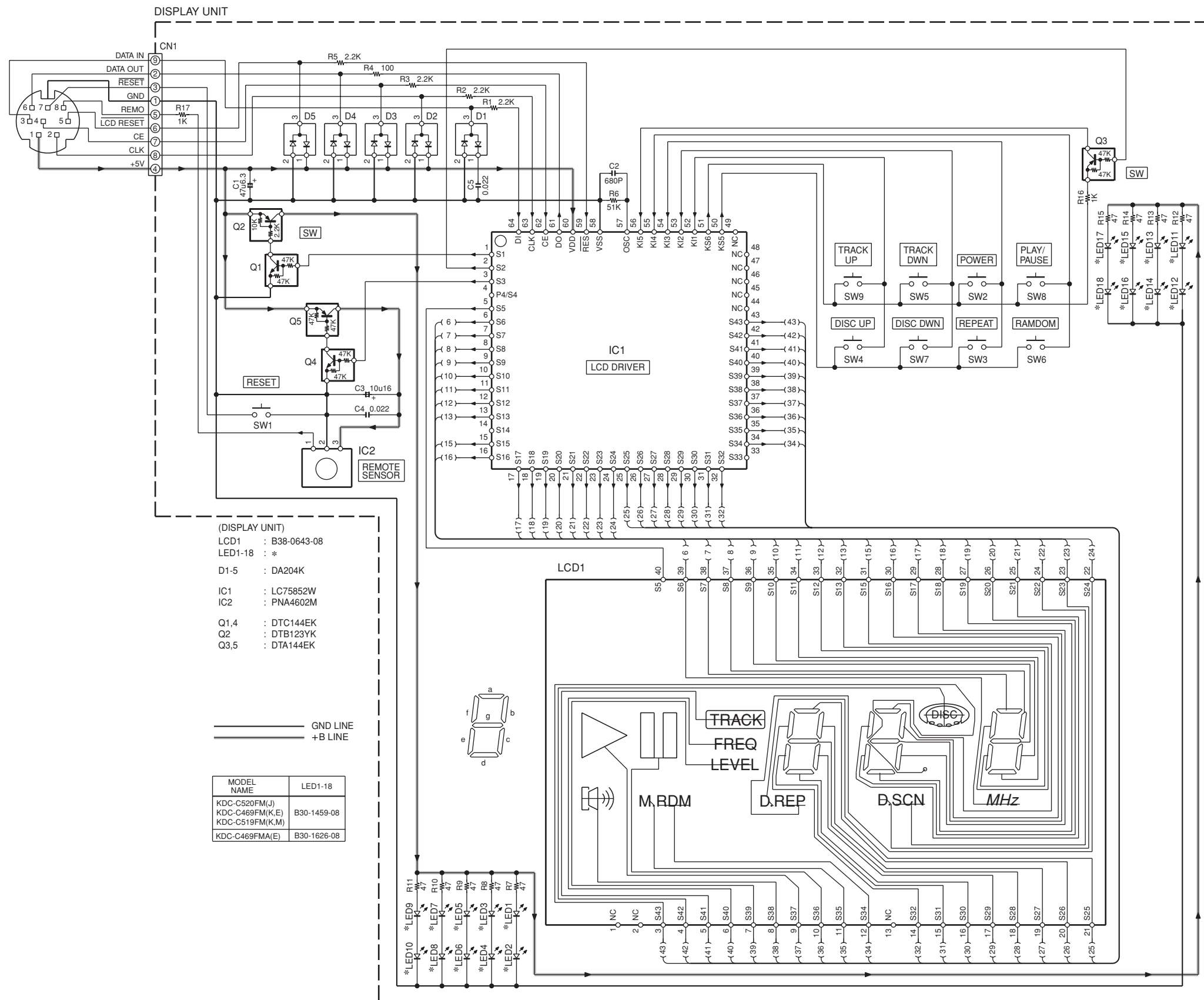

- (DISPLAY UNIT)
- LCD1 : B38-0643-08
 - LED1-18 : *
 - D1-5 : DA204K
 - IC1 : LC75852W
 - IC2 : PNA4602M
 - Q1,4 : DTC144EK
 - Q2 : DTB123YK
 - Q3,5 : DTA144EK

— GND LINE
— +B LINE

MODEL NAME	LED1-18
KDC-C520FM(J)	
KDC-C469FM(K,E)	B30-1459-08
KDC-C519FM(K,M)	
KDC-C469FMA(E)	B30-1626-08

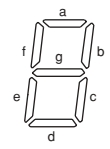

2SB1565

DTA124EUA
DTA143EUA
DTC124EUA

BA1405F

DTA124EK
DTA143EK
DTA144EK
DTB123YK
DTC114YUA
DTC124EK
DTC143TK
DTC144EK
DTC343TK
2SA1162
2SB1295
2SC2714

BR24C02F-W

NJM4565MD

MCH6101

DAN202K
DAN202U

UPC7805AHF

NJM78L05UA

2SB1202

DAP202K
DAP202U
DA204K
DA204U

2SC4081

NJM2060M

CAUTION : For continued safety, replace safety critical components only with manufacturer's recommended parts (refer to parts list).
 ⚠ Indicates safety critical components. To reduce the risk of electric shock, leakage-current or resistance measurements shall be carried out (exposed parts are acceptably insulated from the supply circuit) before the appliance is returned to the customer.

• DC voltages are as measured with a high impedance voltmeter. Values may vary slightly due to variations between individual instruments or/and units.

EXPLODED VIEW (MECHANISM)

- | | | |
|---|---------------|---------------|
| A | φ2x3.5 | : N09-4126-05 |
| B | φ2x2.5(BLK) | : N09-4288-05 |
| C | φ2x5 | : N86-2005-46 |
| D | φ1.7x1.5(BLK) | : N09-4189-05 |
| E | φ2x6 | : N09-4154-05 |
| F | M1.7x3 | : N09-4181-05 |
| G | M1.7x2.2 | : N39-1722-46 |
| H | φ2x3.5 | : N09-4349-05 |
| J | WASHER φ3.8 | : N19-2105-14 |
| K | WASHER φ4 | : N19-2058-04 |
| L | WASHER φ3.8 | : N19-2080-14 |
| M | WASHER φ3.5 | : N19-2028-04 |

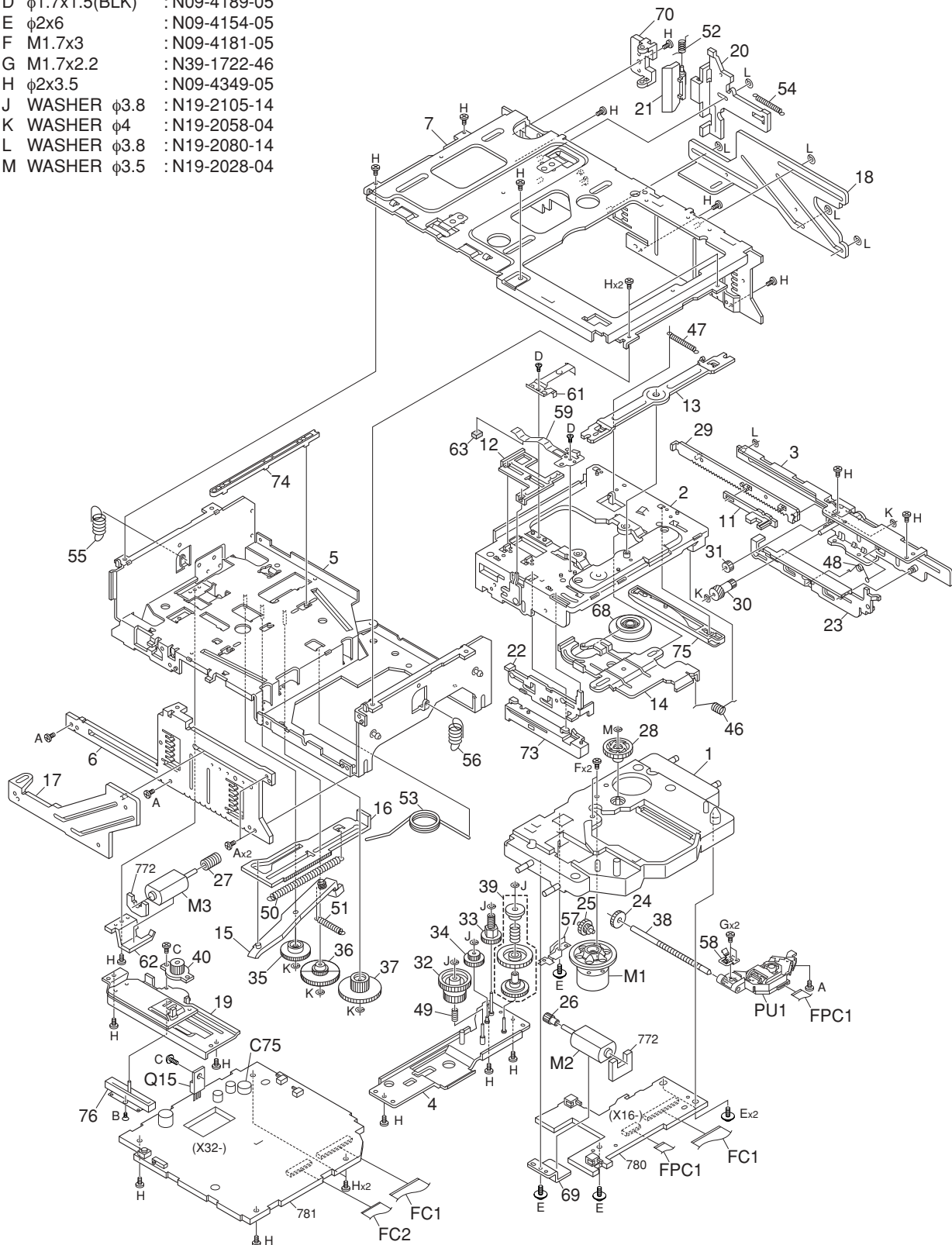

Parts with the exploded numbers larger than 700 are not supplied.

EXPLODED VIEW (RF MODULATOR / DISPLAY UNIT)

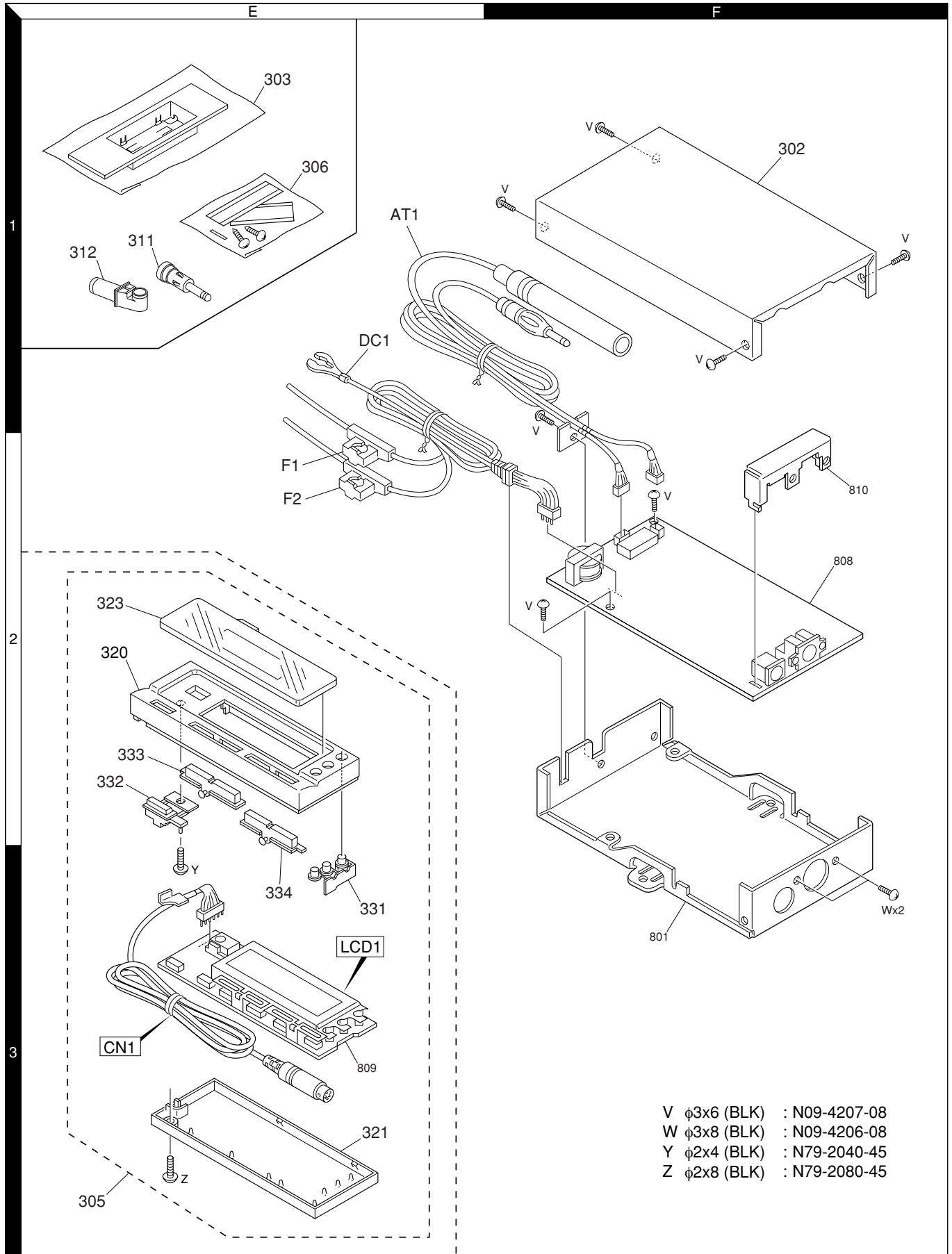

Parts with the exploded numbers larger than 700 are not supplied.

PARTS LIST

* New parts

Parts without **Parts No.** are not supplied.

Les articles non mentionnés dans le **Parts No.** ne sont pas fournis.

Teile ohne **Parts No.** werden nicht geliefert.

Ref. No.	Ad	New	Parts No.	Description	Desti- nation
KDC-C469/Y/FM/FMA, C669/Y					
201	3D		A10-4736-01	CHASSIS	E3E4E5
201	3D		A10-4736-01	CHASSIS	E6
201	3D		A10-4736-01	CHASSIS	M1E1E2
201	3D		A10-4837-01	CHASSIS	KK1K2
201	3D	*	A10-4876-01	CHASSIS	KK1K2
203	1D		A01-2727-11	METALLIC CABINET	E3E4E5
203	1D		A01-2727-11	METALLIC CABINET	E6
203	1D		A01-2727-11	METALLIC CABINET	M1E1E2
203	1D		A01-2744-11	METALLIC CABINET	KK1K2
203	1D	*	A01-2768-01	METALLIC CABINET	KK1K2
204	3C		A21-3530-12	DRESSING PANEL	E3E4E5
204	3C		A21-3530-12	DRESSING PANEL	M1E1E2
204	3C		A21-4080-02	DRESSING PANEL	KK1K2
205	3C		A21-3532-12	DRESSING PANEL	E3E4E5
205	3C		A21-3532-12	DRESSING PANEL	M1E1E2
205	3C		A21-4081-02	DRESSING PANEL	KK1K2
206	2C	*	A22-2845-02	SUB PANEL	
207	3C	*	A64-2904-01	PANEL	M1E1E3
207	3C	*	A64-2905-01	PANEL	E2E4
207	3C	*	A64-2906-01	PANEL	E5E6
207	3C	*	A64-2957-01	PANEL	K
207	3C	*	A64-2958-01	PANEL	K1
207	3C	*	A64-3111-01	PANEL	K2
RC1	1C		A70-2032-05	REMOTE CONTROLLER (RC-504FM)	E5E6
-			B46-0100-50	WARRANTY CARD	
-			B46-0182-14	ID CARD	E1E2E3
-			B46-0182-14	ID CARD	E4E5E6
-			B58-1236-04	CAUTION CARD (CORD)	
-			B58-1275-04	CAUTION CARD	
-			B58-1285-04	CAUTION CARD (O-N FORMAT SW)	E4E5E6
-			B58-1285-04	CAUTION CARD (O-N FORMAT SW)	KK1K2
-			B58-1285-04	CAUTION CARD (O-N FORMAT SW)	M1E2E3
-			B58-1289-04	CAUTION CARD (O-N FORMAT SW)	E1E2
-		*	B64-2346-00	INST.MANUAL(ENG,FRE,SPA,POR)	E4
-		*	B64-2346-00	INST.MANUAL (ENG,FRE,SPA,POR)	KK1K2E3
-		*	B64-2347-00	INST.MANUAL (ENG,FRE,SPA,POR)	K2E5E6
-		*	B64-2350-00	INST.MANUAL (ENG,T-CHI)	M1
-		*	B64-2351-00	INST.MANUAL (ARA)	M1
-		*	B64-2355-00	INST.MANUAL (ENG,RUS,POL)	E1E2
-		*	B64-2356-00	INST.MANUAL (CZE,HUN,CRO)	E1E2
-		*	B64-2365-00	INST.MANUAL (GER,DUT,ITA)	E3E4
-		*	B64-2369-00	INST.MANUAL (GER,DUT,ITA)	E5E6
211			B38-1275-04	CAUTION CARD (TRANSPORT)	
212	3D		D10-4515-03	ARM	
213	1C		D10-4516-04	LEVER	
214	1C		D39-0242-05	DAMPER	
215	1C		E30-4291-05	CORD WITH PLUG	E1E2E3
215	1C		E30-4291-05	CORD WITH PLUG	E4E5E6
215	1C		E30-4291-05	CORD WITH PLUG	K1K2K3
215	1C		E30-4291-05	CORD WITH PLUG	M1
215	1C	*	E30-4954-15	CORD WITH PLUG	E1E2E3
215	1C	*	E30-4954-15	CORD WITH PLUG	E4E5E6

Ref. No.	Ad	New	Parts No.	Description	Desti- nation
215	1C	*	E30-4954-15	CORD WITH PLUG	K1K2K3
215	1C	*	E30-4954-15	CORD WITH PLUG	M1
-			H02-0828-03	INNER CARTON CASE	
-			H10-4730-02	POLYSTYRENE FOAMED FIXTURE	
-			H25-0337-04	PROTECTION BAG (180X300X0.03)	
-			H25-1111-04	PROTECTION BAG (280X450X0.03)	E2E3E4
-			H25-1111-04	PROTECTION BAG (280X450X0.03)	E5E6
-			H25-1111-04	PROTECTION BAG (280X450X0.03)	K2M1E1
-			H25-1115-04	PROTECTION BAG	KK1
-		*	H54-2599-04	ITEM CARTON CASE	KE3
-		*	H54-2600-04	ITEM CARTON CASE	K1E4
-		*	H54-2601-04	ITEM CARTON CASE	K2E5E6
-		*	H54-2602-04	ITEM CARTON CASE	M1
-		*	H54-2603-04	ITEM CARTON CASE	E1
-		*	H54-2604-04	ITEM CARTON CASE	E2
221	1C		J19-5020-03	BRACKET (L)	
222	1C		J19-5021-03	BRACKET (R)	
223	1C		J19-5149-02	HOLDER ASS'Y	
226	1C	*	J99-0614-01	TRAY	
227	2C		K24-3629-04	KNOB	
228	1C		N99-1645-15	SCREW SET	
A	3D		N09-4383-05	STEPPED SCREW	
B	2D		N89-2004-46	BINDING HEAD TAPTITE SCREW	
C	3D		N89-2606-45	BINDING HEAD TAPTITE SCREW	
ME1	2D	*	X92-4770-00	MECHANISM ASS'Y (CHM-2080W)	E3
ME1	2D	*	X92-4770-00	MECHANISM ASS'Y (CHM-2080W)	KM1E1
ME1	2D	*	X92-4770-01	MECHANISM ASS'Y (CHM-2081W)	K2E5E6
ME1	2D	*	X92-4770-02	MECHANISM ASS'Y (CHM-2082W)	K1E2E4
SUB-CIRCUIT UNIT (X13-9840-00)					
CN1			E40-9555-05	FLAT CABLE CONNECTOR (16PIN)	
J1			E56-0825-05	FLAT CABLE CONNECTOR	
SUB-CIRCUIT UNIT (X16-1010-00)					
CN1			E40-9487-05	FLAT CABLE CONNECTOR (23PIN)	
CN2			E40-9536-05	FLAT CABLE CONNECTOR (16PIN)	
W1,2			R92-2053-05	CHIP R 0 J 1/8W	
S1,2			S74-0811-05	MICRO SWITCH	
CD PLAYER UNIT (X32-5470-0x)					
C2			C92-0628-05	CHIP-TAN 10UF 10WV	
C3			CK73GB1H682K	CHIP C 6800PF K	
C4			CK73GB1H152K	CHIP C 1500PF K	
C5			CC73GCH1H470J	CHIP C 47PF J	
C6			CC73GCH1H680J	CHIP C 68PF J	
C7			CC73GCH1H040C	CHIP C 4.0PF C	
C8			CC73GCH1H180J	CHIP C 18PF J	
C9			CK73GB1A224K	CHIP C 0.22UF K	
C10			CK73GB1H222K	CHIP C 2200PF K	
C11			CK73GB1H682K	CHIP C 6800PF K	
C12,13			CK73GB1H103K	CHIP C 0.010UF K	
C14-16			CK73GB1C104K	CHIP C 0.10UF K	
C17			CK73FB1A225K	CHIP C 2.2UF K	
C19			CK73FB1A225K	CHIP C 2.2UF K	

K : KDC-C669 E1 : KDC-C669Y E5 : KDC-C469FM
 K1 : KDC-C469 E2 : KDC-C469Y E6 : KDC-C469FMA
 K2 : KDC-C469FM E3 : KDC-C669
 M1 : KDC-C669 E4 : KDC-C469

△ Indicates safety critical components.

PARTS LIST

* New parts

Parts without **Parts No.** are not supplied.

Les articles non mentionnés dans le **Parts No.** ne sont pas fournis.

Teile ohne **Parts No.** werden nicht geliefert.

CD PLAYER UNIT (X32-5470-0x)

Ref. No.	Add	New	Parts No.	Description	Destination	Ref. No.	Add	New	Parts No.	Description	Destination
C21			CK73GB1H681K	CHIP C 680PF K		R21			RK73GB2A123J	CHIP R 12K J 1/10W	
C23			CK73EB1A475K	CHIP C 4.7UF K		R22			RK73GB2A183J	CHIP R 18K J 1/10W	
C24			CK73GB1H102K	CHIP C 1000PF K		R25			RK73GB2A113J	CHIP R 11K J 1/10W	
C34			C92-0628-05	CHIP-TAN 10UF 10WV		R26			RK73EB2E123J	CHIP R 12K J 1/4W	
C46,47			C92-1393-05	ELECTRO 10UF 16WV		R53,54			RK73GB2A681J	CHIP R 680 J 1/10W	
C48,49			CK73GB1H681K	CHIP C 680PF K		R57,58			RK73GB2A223J	CHIP R 22K J 1/10W	
C52			CK73EB1A475K	CHIP C 4.7UF K		R59			RK73GB2A914J	CHIP R 910K J 1/10W	
C55			C92-0628-05	CHIP-TAN 10UF 10WV		R60,61			RK73EB2E101J	CHIP R 100 J 1/4W	
C56			CK73EB1A475K	CHIP C 4.7UF K		R67			RK73GB2A124J	CHIP R 120K J 1/10W	
C59			C92-1390-05	ELECTRO 100UF 6.3WV		R68			RK73EB2E124J	CHIP R 120K J 1/4W	
C60			CK73EB1A475K	CHIP C 4.7UF K		R69,70			RK73GB2A303J	CHIP R 30K J 1/10W	
C61			CK73GB1C104K	CHIP C 0.10UF K		R71			RK73GB2A912J	CHIP R 9.1K J 1/10W	
C62			C92-1392-05	ELECTRO 100UF 10WV		R72,73			RK73GB2A101J	CHIP R 100 J 1/10W	
C63			CK73EB1A475K	CHIP C 4.7UF K		R74,75			RK73GB2A223J	CHIP R 22K J 1/10W	
C64			C92-1388-05	ELECTRO 470UF 16WV		R76			RK73GB2A104J	CHIP R 100K J 1/10W	
C67-69			CK73GB1C104K	CHIP C 0.10UF K		R77			RK73GB2A183J	CHIP R 18K J 1/10W	
C70			CC73GCH1H101J	CHIP C 100PF J		R78			RK73GB2A104J	CHIP R 100K J 1/10W	
C71,72			CK73FB1A225K	CHIP C 2.2UF K		R79			RK73GB2A332J	CHIP R 3.3K J 1/10W	
C73			CK73GB1C104K	CHIP C 0.10UF K	E3E1	R80			RK73GB2A102J	CHIP R 1.0K J 1/10W	
C73			CK73GB1C104K	CHIP C 0.10UF K	KM1	R81			RK73GB2A103J	CHIP R 10K J 1/10W	
C85			CK73FB1A225K	CHIP C 2.2UF K		R82-84			RK73GB2A102J	CHIP R 1.0K J 1/10W	
C192			CK73GB1H681K	CHIP C 680PF K		R85-87			RK73GB2A104J	CHIP R 100K J 1/10W	
C200-206			CK73GB1C104K	CHIP C 0.10UF K		R93			RK73GB2A224J	CHIP R 220K J 1/10W	
C300			C92-0712-05	CHIP-TAN 22UF 6.3WV		R95,96			RK73GB2A104J	CHIP R 100K J 1/10W	
C301			CK73GB1C104K	CHIP C 0.10UF K		R97,98			RK73GB2A103J	CHIP R 10K J 1/10W	
CN1			E40-9338-05	FLAT CABLE CONNECTOR		R99			RK73GB2A104J	CHIP R 100K J 1/10W	
CN2			E40-9404-05	FLAT CABLE CONNECTOR		R100,101			RK73GB2A102J	CHIP R 1.0K J 1/10W	
L2			L92-0322-05	CHIP FERRITE		R102			RK73GB2A104J	CHIP R 100K J 1/10W	
X1			L78-0596-05	RESONATOR (16.93MHz)		R105,106			RK73GB2A102J	CHIP R 1.0K J 1/10W	
X2			L78-0568-05	RESONATOR (12.5MHz)		R107			RK73GB2A101J	CHIP R 100 J 1/10W	
CP1			R90-0720-05	MULTI-COMP 100K X4		R108			RK73GB2A104J	CHIP R 100K J 1/10W	
CP3			R90-0720-05	MULTI-COMP 100K X4		R110,111			RK73GB2A104J	CHIP R 100K J 1/10W	
CP5,6			R90-1014-05	MULTI-COMP 100 X4		R114			RK73GB2A103J	CHIP R 10K J 1/10W	
CP7,8			R90-0720-05	MULTI-COMP 100K X4		R120			RK73GB2A393J	CHIP R 39K J 1/10W	
CP9			R90-0725-05	MULTI-COMP 1K X2		R121			RK73GB2A103J	CHIP R 10K J 1/10W	
CP10,11			R90-1014-05	MULTI-COMP 100 X4		R122,123			RK73GB2A102J	CHIP R 1.0K J 1/10W	
CP10,11			R90-1014-05	MULTI-COMP 100 X4	E1E3	R124			RK73GB2A223J	CHIP R 22K J 1/10W	
CP12			R90-1014-05	MULTI-COMP 100 X4	KM1	R127			RK73GB2A104J	CHIP R 100K J 1/10W	
CP14,15			R90-0720-05	MULTI-COMP 100K X4		R129			RK73GB2A102J	CHIP R 1.0K J 1/10W	
CP16			R90-0724-05	MULTI-COMP 1K X4		R133,134			RK73GB2A104J	CHIP R 100K J 1/10W	
CP17			R90-0720-05	MULTI-COMP 100K X4		R135-138			RK73GB2A101J	CHIP R 100 J 1/10W	
R4			RK73GB2A391J	CHIP R 390 J 1/10W		R139-143			RK73GB2A104J	CHIP R 100K J 1/10W	
R5			RK73GB2A302J	CHIP R 3.0K J 1/10W		R148,149			RK73GB2A101J	CHIP R 100 J 1/10W	
R7			RK73GB2A302J	CHIP R 3.0K J 1/10W		R150			RK73GB2A102J	CHIP R 1.0K J 1/10W	
R8			RK73EB2E100J	CHIP R 10 J 1/4W		R152			RK73GB2A913J	CHIP R 91K J 1/10W	
R9			RK73GB2A102J	CHIP R 1.0K J 1/10W		R153,154			RK73GB2A472J	CHIP R 4.7K J 1/10W	
R10			RK73GB2A104J	CHIP R 100K J 1/10W		R155,156			RK73GB2A101J	CHIP R 100 J 1/10W	
R11-14			RK73GB2A103J	CHIP R 10K J 1/10W		R157			RK73GB2A102J	CHIP R 1.0K J 1/10W	E4E5E6
R15			RK73GB2A104J	CHIP R 100K J 1/10W		R157			RK73GB2A102J	CHIP R 1.0K J 1/10W	K1K2E2
R16			RK73GB2A562J	CHIP R 5.6K J 1/10W		R161			RK73GB2A163J	CHIP R 16K J 1/10W	
R17			RK73EB2E103J	CHIP R 10K J 1/4W		R162			RK73GB2A472J	CHIP R 4.7K J 1/10W	
R18			RK73GB2A103J	CHIP R 10K J 1/10W		R190			RK73GB2A223J	CHIP R 22K J 1/10W	
R19			RK73GB2A333J	CHIP R 33K J 1/10W		R191			RK73GB2A123J	CHIP R 12K J 1/10W	
R20			RK73GB2A104J	CHIP R 100K J 1/10W		R205			RK73EB2E102J	CHIP R 1.0K J 1/4W	
						R206			RK73GB2A102J	CHIP R 1.0K J 1/10W	

K : KDC-C669 **E1** : KDC-C669Y **E5** : KDC-C469FM
K1 : KDC-C469 **E2** : KDC-C469Y **E6** : KDC-C469FMA
K2 : KDC-C469FM **E3** : KDC-C669
M1 : KDC-C669 **E4** : KDC-C469

△ Indicates safety critical components.

PARTS LIST

* New parts

Parts without **Parts No.** are not supplied.

Les articles non mentionnés dans le **Parts No.** ne sont pas fournis.

Teile ohne **Parts No.** werden nicht geliefert.

CD PLAYER UNIT (X32-5470-0x)

Ref. No.	A d d	N e w	Parts No.	Description	Desti- nation
W2			R92-1252-05	CHIP R 0 OHM J 1/16W	
W3			R92-2053-05	CHIP R 0 J 1/8W	
W5-7			R92-1252-05	CHIP R 0 OHM J 1/16W	
S1			S68-0823-05	PUSH SWITCH	
S2			S70-0838-05	TACT SWITCH	
S3			S68-0823-05	PUSH SWITCH	
D1			DAP202K	DIODE	
D3,4			MA3056-M	ZENER DIODE	
D5			MA8075-M	ZENER DIODE	
D7			MA3056-M	ZENER DIODE	
D8			MA8062-M	ZENER DIODE	
D9,10			M1F60	DIODE	
D11			1SR154-400	DIODE	
D12			DA204U	DIODE	
D14			MA8091-M	ZENER DIODE	
D15			DAP202K	DIODE	
D16			DAP202U	DIODE	
D21,22			DAN202K	DIODE	
D23,24			DAN202U	DIODE	
IC1			UPD63711AGC	MOS-IC	
IC4			KIA78L05F	ANALOGUE IC	
IC5			LA6576	ANALOGUE IC	
IC7			UPD784214GC098	MI-COM IC	
IC8			BR24C02F-W	MEMORY IC	
IC8			CAT24WC02JI	MEMORY IC	
IC8			M24C02-WMN6T	MEMORY IC	
IC8			S-24C02BFJA	MEMORY IC	
IC8			24LC02BT-ISN	MEMORY IC	
IC9			S-80830CNNB	MOS-IC	
IC11			LC3564BT-70	MEMORY IC	
IC11			LC3564BT-70	MEMORY IC	E1E3 KM1
Q1			MCH6101	TRANSISTOR	
Q4			DTA124EK	TRANSISTOR	
Q5			DTA124EUA	TRANSISTOR	
Q6,7			DTC343TK	TRANSISTOR	
Q8			DTA124EK	TRANSISTOR	
Q9			2SB1202	TRANSISTOR	
Q10			2SB1295	TRANSISTOR	
Q11			DTC124EK	TRANSISTOR	
Q13			DTC124EUA	TRANSISTOR	
Q14			DTA143EUA	TRANSISTOR	
Q16			2SC4081	TRANSISTOR	
Q17			DTA143EK	TRANSISTOR	
Q18,19			DTC124EUA	TRANSISTOR	
Q20			DTC124EK	TRANSISTOR	
Q21			2SB1202	TRANSISTOR	
Q22			2SC4081	TRANSISTOR	
Q30			DTC114YUA	TRANSISTOR	
Q31			DTC124EUA	TRANSISTOR	
MECHANISM ASSY (X92-4770-0x)					
1	2B		A10-4745-13	CHASSIS ASS'Y	
2	2B		A10-4748-02	CHASSIS CALKING ASS'Y	
3	2B		A10-4751-03	CHASSIS CALKING ASS'Y	
4	3A		A10-4754-04	CHASSIS CALKING ASS'Y	

Ref. No.	A d d	N e w	Parts No.	Description	Desti- nation
5	2A		A10-4763-02	CHASSIS CALKING ASS'Y	
6	2A		A10-4765-02	CHASSIS	
7	1A		A10-4766-02	CHASSIS CALKING ASS'Y	
C75	3A		C90-2945-05	ELECTRO 0.047F 5.5WV	E1E2E3
C75	3A		C90-2945-05	ELECTRO 0.047F 5.5WV	E4
C75	3A		C90-2945-05	ELECTRO 0.047F 5.5WV	KK1M1
11	2B		D10-4546-03	ARM	
12	2A		D10-4527-03	SLIDER	
13	2B		D10-4528-03	ARM	
14	2B		D10-4529-03	LEVER	
15	3A		D10-4531-04	LEVER ASS'Y	
16	2A		D10-4533-03	LEVER	
17	2A		D10-4541-04	SLIDER ASS'Y	
18	1B		D10-4543-13	SLIDER	
19	3A		D10-4537-04	SLIDER ASS'Y	
20	1B		D10-4545-13	ARM	
21	1B		D10-4548-03	LEVER	
22	2B		D12-0630-02	CAM	
23	2B		D12-0631-02	CAM	
24	3B		D13-2185-04	GEAR	
25	3B		D13-2186-04	GEAR	
26	3B		D13-2187-04	GEAR	
27	3A		D13-2188-04	WORM	
28	2B		D13-2092-04	GEAR	
29	2B		D13-2093-04	GEAR ASS'Y	
30	2B		D13-2095-04	GEAR	
31	2B		D13-2096-04	GEAR	
32	3A		D13-2099-04	GEAR	
33	3A		D13-2100-04	GEAR	
34	3A		D13-2101-04	GEAR	
35	3A		D13-2102-04	GEAR	
36	3A		D13-2103-04	GEAR	
37	3A		D13-2104-04	GEAR	
38	3B		D19-0636-04	LEAD SCREW	
39	3A		D19-0637-04	CLUTCH ASS'Y	
40	3A		D39-0225-05	DAMPER	
FC1	3A		E39-0172-15	FLAT CABLE (23PIN)	
FC2	3A		E39-0173-15	FLAT CABLE (16PIN)	
46	2B		G01-3036-04	TORSION COIL SPRING	
47	1B		G01-3037-04	EXTENSION SPRING	
48	2B		G01-3038-04	TORSION COIL SPRING	
49	3A		G01-3039-04	COMPRESSION SPRING	
50	3A		G01-3040-04	EXTENSION SPRING	
51	3A		G01-3041-04	EXTENSION SPRING	
52	1B		G01-3042-04	TORSION COIL SPRING	
53	2A		G01-3043-04	TORSION COIL SPRING	
54	1B		G01-3044-04	EXTENSION SPRING	
55	2A		G01-3046-04	EXTENSION SPRING (SILVER)	
56	2A		G01-3047-04	EXTENSION SPRING (BROWN)	
57	3B		G02-1374-04	FLAT SPRING	
58	3B		G02-1375-03	FLAT SPRING	
59	2B		G02-1376-03	FLAT SPRING	
61	2B		G02-1378-14	FLAT SPRING	

K : KDC-C669 **E1** : KDC-C669Y **E5** : KDC-C469FM
K1 : KDC-C469 **E2** : KDC-C469Y **E6** : KDC-C469FMA
K2 : KDC-C469FM **E3** : KDC-C669
M1 : KDC-C669 **E4** : KDC-C469

△ Indicates safety critical components.

PARTS LIST

* New parts

Parts without **Parts No.** are not supplied.

Les articles non mentionnés dans le **Parts No.** ne sont pas fournis.

Teile ohne **Parts No.** werden nicht geliefert.

MECHANISM ASSY (X92-4770-0x)

Ref. No.	Added	New	Parts No.	Description	Destination
62	3A		G02-1380-04	FLAT SPRING	
63	2A		G10-1045-14	FELT	
68	2B		J11-0637-03	CLAMPER	
69	3B		J21-9592-04	MOUNTING HARDWARE	
70	1B		J21-9597-03	MOUNTING HARDWARE	
FPC1	3B		J84-0141-05	FLEXIBLE PRINTED WIRING BOARD	
A	2A		N09-4126-05	MACHINE SCREW	
B	3A		N09-4288-05	TAPTITE SCREW	
C	3A		N86-2005-46	BINDING HEAD TAPTITE SCREW	
D	2B		N09-4189-05	TAPTITE SCREW	
E	3B		N09-4154-05	TAPTITE SCREW	
F	2B		N09-4181-05	MACHINE SCREW	
G	3B		N39-1722-46	PAN HEAD MACHIN SCREW	
H	1A		N09-4349-05	TAPTITE SCREW	
J	3A		N19-2105-14	FLAT WASHER	
K	3A		N19-2058-04	FLAT WASHER	
L	1B		N19-2080-14	FLAT WASHER	
M	2B		N19-2028-04	FLAT WASHER	
M1	3B		T42-0797-04	DC MOTOR ASSY	
M2,3	3A		T42-0788-05	DC MOTOR	
Q15	3A		2SB1548(P)	TRANSISTOR	
Q15	3A		2SB1565(E,F)	TRANSISTOR	
PU1	3B	*	X93-2000-00	OPTICAL PICKUP ASS'Y	
RF MODULATOR					
302	1F		A01-2819-08	CASE	K2
302	1F		A01-2824-08	CASE	E5E6
303	1E		B07-2138-08	HOLDER ASSY	K2E5E6
AT1	1E		E30-4310-08	ANTENNA CORD ASSY	K2E5E6
DC1	1E		E30-4733-08	DC CORD	K2E5E6
F1,2	2E		F06-3026-05	FUSE (3A)	K2E5E6
V	1F		N09-4207-08	SCREW (3X6,Ni-B)	K2E5E6
W	3F		N09-4206-08	SCREW (for CN102 x2)(3X8)	K2E5E6
305	3E		T95-0244-08	DISPLAY UNIT ASSY	E5
305	3E		T95-0247-08	DISPLAY UNIT ASSY	K2
305	3E		T95-0251-08	DISPLAY UNIT ASSY	E6
311	1E		T90-0512-05	ANTENNA ADAPTOR	E5E6
312	1E		T90-0521-05	ANTENNA ADAPTOR	E5E6
306	1E		W01-0763-08	MAGICTAPE ASSY	K2E5E6
RF MODULATOR UNIT					
C1			C90-2583-05	ELECTRO 1000UF 16WV	K2E5E6
C2			CK73FB1H223K	CHIP C 0.022UF K	K2E5E6
C3			CE04NW1H4R7M	ELECTRO 4.7UF 50WV	K2E5E6
C6			CE04NW1C100M	ELECTRO 10UF 16WV	K2E5E6
C7			CE04NW1H010M	ELECTRO 1.0UF 50WV	K2E5E6
C8			CK73FB1H102K	CHIP C 1000PF K	K2E5E6

Ref. No.	Added	New	Parts No.	Description	Destination
C9,10			CK73FB1H103K	CHIP C 0.010UF K	K2E5E6
C11,12			CC73FCH1H220J	CHIP C 22PF J	K2E5E6
C13-17			CK73FB1H102K	CHIP C 1000PF K	K2E5E6
C19			CE04DW1A101M	ELECTRO 100UF 10WV	K2E5E6
C20			CE04DW1E221M	ELECTRO 220UF 25WV	K2E5E6
C24			CE04DW1C471M	ELECTRO 470UF 16WV	K2E5E6
C30			CE04DW1A102M	ELECTRO 1000UF 10WV	K2E5E6
C31			CE04DW1A221M	ELECTRO 220UF 10WV	K2E5E6
C32			CE04DW1A101M	ELECTRO 100UF 10WV	K2E5E6
C33			C90-2583-05	ELECTRO 1000UF 16WV	K2E5E6
C34			CE04NW1H010M	ELECTRO 1.0UF 50WV	K2E5E6
C35			CK73FB1H103K	CHIP C 0.010UF K	K2E5E6
C36			C90-2689-05	ELECTRO 3300UF 16WV	K2E5E6
C103			CK73FB1H103K	CHIP C 0.010UF K	K2
C103			CK73FB1H472K	CHIP C 4700PF K	E5E6
C104			CE04NW1C100M	ELECTRO 10UF 16WV	K2E5E6
C105			CE04DW1A221M	ELECTRO 220UF 10WV	K2E5E6
C106			CE04NW1C100M	ELECTRO 10UF 16WV	K2E5E6
C107			CC73FCH1H271J	CHIP C 270PF J	K2E5E6
C108			CK73FB1H102K	CHIP C 1000PF K	K2
C108			CK73FB1H681K	CHIP C 680PF K	E5E6
C109,110			CK73FF1H104Z	CHIP C 0.10UF Z	K2E5E6
C111			CE04NW1H010M	ELECTRO 1.0UF 50WV	K2E5E6
C112			CK73FB1H332K	CHIP C 3300PF K	K2E5E6
C113			CC73FCH1H181J	CHIP C 180PF J	K2E5E6
C114			CK73FB1H153K	CHIP C 0.015UF K	K2E5E6
C203			CK73FB1H103K	CHIP C 0.010UF K	K2
C203			CK73FB1H472K	CHIP C 4700PF K	E5E6
C204			CE04NW1C100M	ELECTRO 10UF 16WV	K2E5E6
C205			CE04DW1A221M	ELECTRO 220UF 10WV	K2E5E6
C206			CE04NW1C100M	ELECTRO 10UF 16WV	K2E5E6
C207			CC73FCH1H271J	CHIP C 270PF J	K2E5E6
C208			CK73FB1H102K	CHIP C 1000PF K	K2
C208			CK73FB1H681K	CHIP C 680PF K	E5E6
C209,210			CK73FF1H104Z	CHIP C 0.10UF Z	K2E5E6
C211			CE04NW1H010M	ELECTRO 1.0UF 50WV	K2E5E6
C212			CK73FB1H332K	CHIP C 3300PF K	K2E5E6
C213			CC73FCH1H181J	CHIP C 180PF J	K2E5E6
C214			CK73FB1H153K	CHIP C 0.015UF K	K2E5E6
C301			CE04NW1C100M	ELECTRO 10UF 16WV	K2E5E6
C302			CK73FB1H103K	CHIP C 0.010UF K	K2E5E6
C303			CC73FCH1H221J	CHIP C 220PF J	K2E5E6
C304			CC73FCH1H100D	CHIP C 10PF D	K2E5E6
C305			CK73FB1H103K	CHIP C 0.010UF K	K2E5E6
C306			CC73FCH1H221J	CHIP C 220PF J	K2E5E6
C308			CK73FB1H333K	CHIP C 0.033UF K	K2E5E6
C310			CC73FCH1H330J	CHIP C 33PF J	K2E5E6
C312			CK73FB1H103K	CHIP C 0.010UF K	K2E5E6
C314			CE04NW1HR22M	ELECTRO 0.22UF 50WV	K2E5E6
C315			CE04DW1A101M	ELECTRO 100UF 10WV	K2E5E6
C316			CK73FB1H103K	CHIP C 0.010UF K	K2E5E6
C317			CE04NW1H2R2M	ELECTRO 2.2UF 50WV	K2E5E6
C318,319			CK73FB1H103K	CHIP C 0.010UF K	K2E5E6
C320			CC73FCH1H181J	CHIP C 180PF J	K2E5E6
C321			CE04NW1H010M	ELECTRO 1.0UF 50WV	K2E5E6

K : KDC-C669 **E1** : KDC-C669Y **E5** : KDC-C469FM
K1 : KDC-C469 **E2** : KDC-C469Y **E6** : KDC-C469FMA
K2 : KDC-C469FM **E3** : KDC-C669
M1 : KDC-C669 **E4** : KDC-C469

△ Indicates safety critical components.

PARTS LIST

* New parts

Parts without **Parts No.** are not supplied.

Les articles non mentionnés dans le **Parts No.** ne sont pas fournis.

Teile ohne **Parts No.** werden nicht geliefert.

RF MODULATOR UNIT

Ref. No.	A d d	N e w	Parts No.	Description	Desti- nation
C322			CC73FUJ1H221J	CHIP C 220PF J	K2E5E6
C323			CC73FUJ1H680J	CHIP C 68PF J	K2E5E6
C324			CC73FUJ1H150J	CHIP C 15PF J	K2E5E6
C325			CK73FB1H103K	CHIP C 0.010UF K	K2E5E6
C326			CE04DW1E470M	ELECTRO 47UF 25WV	K2E5E6
C327			CC73FUJ1H150J	CHIP C 15PF J	K2E5E6
C328			CC73FCH1H020C	CHIP C 2.0PF C	K2E5E6
C329			CC73FCH1H150J	CHIP C 15PF J	K2E5E6
C330			CK73FB1H103K	CHIP C 0.010UF K	K2E5E6
C331			CC73FCH1H010C	CHIP C 1.0PF C	K2E5E6
C332			CC73FCH1H050C	CHIP C 5.0PF C	K2E5E6
C333,334			CC73FCH1H330J	CHIP C 33PF J	K2E5E6
C335			CE04NW1H4R7M	ELECTRO 4.7UF 50WV	K2E5E6
C336			CK73FB1H222K	CHIP C 2200PF K	K2E5E6
C338			CC73FCH1H050C	CHIP C 5.0PF C	K2E5E6
VC301			C05-0513-08	TRIMMER 20P	K2E5E6
CN101			E56-0811-05	CONNECTOR (8P)	K2E5E6
CN102			E56-0833-08	CONNECTOR (13P)	K2E5E6
CN104,105			E40-3237-05	PIN ASSY	K2E5E6
L1			L33-0934-08	CHOKING COIL	K2E5E6
L301			L33-1043-08	SMALL FIXED INDUCTOR (0.22uH)	K2E5E6
L302,303			L33-0976-08	SMALL FIXED INDUCTOR (2.2uH)	K2E5E6
L304			L33-1043-08	SMALL FIXED INDUCTOR (0.22uH)	K2E5E6
L305			L33-1042-08	SMALL FIXED INDUCTOR (0.12uH)	K2E5E6
X301			L77-2716-08	CRYSTAL RESONATOR (38KHz)	K2E5E6
X302			L77-2062-08	CRYSTAL RESONATOR (4.5MHz)	K2E5E6
R1			RD14BB2C242J	RD 2.4K J 1/6W	K2E5E6
R2			RD14BB2C222J	RD 2.2K J 1/6W	K2E5E6
R6			RK73FB2A223J	CHIP R 22K J 1/10W	K2E5E6
R7			R92-2148-08	CHIP R 22 J 2W	K2E5E6
R8			RD14BB2C223J	RD 22K J 1/6W	K2E5E6
R9			RD14BB2C222J	RD 2.2K J 1/6W	K2E5E6
R11			RD14BB2C102J	RD 1.0K J 1/6W	K2E5E6
R12			RD14BB2C103J	RD 10K J 1/6W	K2E5E6
R13			RD14BB2C104J	RD 100K J 1/6W	K2E5E6
R14			RD14BB2C332J	RD 3.3K J 1/6W	K2E5E6
R15			RD14BB2C104J	RD 100K J 1/6W	K2E5E6
R16			RD14BB2C332J	RD 3.3K J 1/6W	K2E5E6
R17			RD14BB2C102J	RD 1.0K J 1/6W	K2E5E6
R18			RK73FB2A104J	CHIP R 100K J 1/10W	K2E5E6
R19			RD14BB2C332J	RD 3.3K J 1/6W	K2E5E6
R20			RD14BB2C102J	RD 1.0K J 1/6W	K2E5E6
R21			RD14BB2C472J	RD 4.7K J 1/6W	K2E5E6
R22,23			RD14BB2C102J	RD 1.0K J 1/6W	K2E5E6
R24			RD14BB2C472J	RD 4.7K J 1/6W	K2E5E6
R25,26			RD14BB2C102J	RD 1.0K J 1/6W	K2E5E6
R27,28			RK73FB2A103J	CHIP R 10K J 1/10W	K2E5E6
R31			RK73FB2A473J	CHIP R 47K J 1/10W	K2E5E6
R33			RK73FB2A473J	CHIP R 47K J 1/10W	K2E5E6
R34			RK73FB2A182J	CHIP R 1.8K J 1/10W	K2E5E6
R35			RK73FB2A151J	CHIP R 150 J 1/10W	K2E5E6
R102			RK73FB2A152J	CHIP R 1.5K J 1/10W	K2E5E6
R103			RK73FB2A682J	CHIP R 6.8K J 1/10W	K2E5E6

Ref. No.	A d d	N e w	Parts No.	Description	Desti- nation
R104			RK73FB2A103J	CHIP R 10K J 1/10W	K2E5E6
R105-108			R92-0363-05	CHIP R 10K F 1/10W	K2E5E6
R109			RK73FB2A182J	CHIP R 1.8K J 1/10W	K2E5E6
R110			RK73FB2A391J	CHIP R 390 J 1/10W	K2E5E6
R111			RK73FB2A102J	CHIP R 1.0K J 1/10W	K2E5E6
R112			RK73FB2A753J	CHIP R 75K J 1/10W	K2E5E6
R113			RK73FB2A104J	CHIP R 100K J 1/10W	K2E5E6
R114-116			RK73FB2A682J	CHIP R 6.8K J 1/10W	K2E5E6
R202			RK73FB2A152J	CHIP R 1.5K J 1/10W	K2E5E6
R203			RK73FB2A682J	CHIP R 6.8K J 1/10W	K2E5E6
R204			RK73FB2A103J	CHIP R 10K J 1/10W	K2E5E6
R205-208			R92-0363-05	CHIP R 10K F 1/10W	K2E5E6
R209			RK73FB2A182J	CHIP R 1.8K J 1/10W	K2E5E6
R210			RK73FB2A391J	CHIP R 390 J 1/10W	K2E5E6
R212			RK73FB2A753J	CHIP R 75K J 1/10W	K2E5E6
R213			RK73FB2A104J	CHIP R 100K J 1/10W	K2E5E6
R214-216			RK73FB2A682J	CHIP R 6.8K J 1/10W	K2E5E6
R301			RK73FB2A154J	CHIP R 150K J 1/10W	K2E5E6
R302			RK73FB2A123J	CHIP R 12K J 1/10W	K2E5E6
R306			RK73FB2A103J	CHIP R 10K J 1/10W	K2E5E6
R307			RK73FB2A472J	CHIP R 4.7K J 1/10W	K2E5E6
R308			RK73FB2A124J	CHIP R 120K J 1/10W	E5E6
R308			RK73FB2A154J	CHIP R 150K J 1/10W	K2
R314			RK73FB2A473J	CHIP R 47K J 1/10W	K2E5E6
R316			RK73FB2A122J	CHIP R 1.2K J 1/10W	K2E5E6
R317			RK73FB2A242J	CHIP R 2.4K J 1/10W	K2E5E6
R318			RK73FB2A332J	CHIP R 3.3K J 1/10W	K2E5E6
R319			RD14BB2C122J	RD 1.2K J 1/6W	K2E5E6
R320			RK73FB2A103J	CHIP R 10K J 1/10W	K2E5E6
R322			RD14BB2C472J	RD 4.7K J 1/6W	K2E5E6
R323			RK73FB2A471J	CHIP R 470 J 1/10W	K2E5E6
R325,326			RK73FB2A223J	CHIP R 22K J 1/10W	K2E5E6
R327			RK73FB2A473J	CHIP R 47K J 1/10W	K2E5E6
R328			RK73FB2A271J	CHIP R 270 J 1/10W	K2E5E6
R329			RK73FB2A470J	CHIP R 47 J 1/10W	K2E5E6
R330			RK73FB2A331J	CHIP R 330 J 1/10W	K2E5E6
R331			RK73FB2A473J	CHIP R 47K J 1/10W	K2E5E6
R332			RK73FB2A101J	CHIP R 100 J 1/10W	K2E5E6
R333			RK73FB2A470J	CHIP R 47 J 1/10W	K2E5E6
R334			RK73FB2A472J	CHIP R 4.7K J 1/10W	K2E5E6
R337,338			RK73FB2A472J	CHIP R 4.7K J 1/10W	K2E5E6
R339,340			RK73FB2A391J	CHIP R 390 J 1/10W	K2E5E6
R343			RK73FB2A101J	CHIP R 100 J 1/10W	K2E5E6
R346			RK73FB2A472J	CHIP R 4.7K J 1/10W	K2E5E6
R348			RK73FB2A224J	CHIP R 220K J 1/10W	K2E5E6
VR301			R32-0208-08	TRIMMING POT. 33K(B)	K2E5E6
VR303			R32-0207-08	TRIMMING POT. 10K(B)	K2E5E6
RL1			S76-0802-08	MAGNET RELAY	K2E5E6
D1			DSK10C-ET1	DIODE	K2E5E6
D2			DSK10C-BT	DIODE	K2E5E6
D5			DSK10C-ET1	DIODE	K2E5E6
D8,9			1SS131	DIODE	K2E5E6
D12,13			1SS131	DIODE	K2E5E6

K : KDC-C669 **E1** : KDC-C669Y **E5** : KDC-C469FM
K1 : KDC-C469 **E2** : KDC-C469Y **E6** : KDC-C469FMA
K2 : KDC-C469FM **E3** : KDC-C669
M1 : KDC-C669 **E4** : KDC-C469

△ Indicates safety critical components.

PARTS LIST

* New parts

Parts without **Parts No.** are not supplied.

Les articles non mentionnés dans le **Parts No.** ne sont pas fournis.

Teile ohne **Parts No.** werden nicht geliefert.

RF MODULATOR UNIT

Ref. No.	Add	New	Parts No.	Description	Destination	Ref. No.	Add	New	Parts No.	Description	Destination
D14			DSK10C-ET1	DIODE	K2E5E6	R16,17			RK73GB1J102J	CHIP R 1.0K J 1/16W	K2E5E6
D15			DSK10C-BT	DIODE	K2E5E6						
D16			1SS131	DIODE	K2E5E6	SW1-9			S70-0828-08	TACT SWITCH	K2E5E6
D101			DA204K	DIODE	K2E5E6						
D201			DA204K	DIODE	K2E5E6	D1-5			DA204K	DIODE	K2E5E6
D302			DA204K	DIODE	K2E5E6	IC1			LC75852W	IC (LCD DRIVER)	K2E5E6
IC1		*	UPC7805AHF	IC (VOLTAGE REGULATOR/ +5V)	K2E5E6	IC2			PNA4602M	IC (REMOTE SENSOR)	K2E5E6
IC2			LC72329-9B24	IC (MICRO COMPUTER)	K2E5E6	Q1			DTC144EK	DIGITAL TRANSISTOR	K2E5E6
IC4			NJM78L05UA	IC (VOLTAGE REGULATOR/ +5V)	K2E5E6	Q2			DTB123YK	DIGITAL TRANSISTOR	K2E5E6
IC101			NJM2060M	IC (OP AMP X4)	K2E5E6	Q3			DTA144EK	DIGITAL TRANSISTOR	K2E5E6
IC102			NJM4565MD	IC (OP AMP X2)	K2E5E6	Q4			DTC144EK	DIGITAL TRANSISTOR	K2E5E6
IC301			BA1405F	IC (MPX)	K2E5E6	Q5			DTA144EK	DIGITAL TRANSISTOR	K2E5E6
IC302			NJM4565MD	IC (OP AMP X2)	K2E5E6						
Q1			DTC124EK	DIGITAL TRANSISTOR	K2E5E6						
Q2			2SA1782(T,U)	TRANSISTOR	K2E5E6						
Q3			DTC124EK	DIGITAL TRANSISTOR	K2E5E6						
Q4,5			DTC143TK	DIGITAL TRANSISTOR	K2E5E6						
Q6			DTA124EK	DIGITAL TRANSISTOR	K2E5E6						
Q8			DTC143TK	DIGITAL TRANSISTOR	K2E5E6						
Q9			2SC4640(T,U)	TRANSISTOR	K2E5E6						
Q101			2SK2158	FET	K2E5E6						
Q201			2SK2158	FET	K2E5E6						
Q303			2SA1162(GR)	TRANSISTOR	K2E5E6						
Q304,305			2SK2158	FET	K2E5E6						
Q306			2SK508L	FET	K2E5E6						
Q307			2SC2714(Y)	TRANSISTOR	K2E5E6						
Q308-310			2SK2158	FET	K2E5E6						
VD301			HVU306A-3	VARIABLE DIODE	K2E5E6						
ZD1-7			MTZ6.2J(B)	ZENER DIODE	K2E5E6						
DISPLAY UNIT											
320			A02-1460-08	FRONT CASE	K2E5E6						
321			A02-1446-08	REAR CASE	K2E5E6						
323			B10-3055-08	FRONT GLASS ASSY	K2E5						
323			B10-4108-08	FRONT GLASS ASSY	E6						
LCD1			B38-0643-08	LCD	K2E5E6						
LED1-18			B30-1459-08	LED	K2E5						
LED1-18			B30-1626-08	LED (RED) E6							
C1			C92-0047-05	CHIP-ELE 47UF 6.3WV	K2E5E6						
C2			CK73GB1H681K	CHIP C 680PF K	K2E5E6						
C3			C92-0037-05	CHIP-ELE 10UF 16WV	K2E5E6						
C4,5			CK73FB1H223K	CHIP C 0.022UF K	K2E5E6						
CN1			E30-4309-08	DIN CORD ASSY (8P)	K2E5E6						
331			K25-0713-08	KNOB (REP, RDM, PLAY/PAUSE)	K2E5E6						
332			K29-5576-08	KNOB ASSY (PWR, RESET)	K2E5E6						
333			K29-5585-08	KNOB (TRACK)	K2E5E6						
334			K29-5586-08	KNOB (DISC)	K2E5E6						
Y			N79-2040-45	SCREW (POWER-KEY x1)	K2E5E6						
Z			N79-2080-45	SCREW (REAR CASE x1)	K2E5E6						
R1-3			RK73GB1J222J	CHIP R 2.2K J 1/16W	K2E5E6						
R4			RK73GB1J101J	CHIP R 100 J 1/16W	K2E5E6						
R5			RK73GB1J222J	CHIP R 2.2K J 1/16W	K2E5E6						
R6			RK73GB1J513J	CHIP R 51K J 1/16W	K2E5E6						
R7-15			RK73FB2A470J	CHIP R 47 J 1/10W	K2E5E6						

K : KDC-C669 **E1** : KDC-C669Y **E5** : KDC-C469FM
K1 : KDC-C469 **E2** : KDC-C469Y **E6** : KDC-C469FMA
K2 : KDC-C469FM **E3** : KDC-C669
M1 : KDC-C669 **E4** : KDC-C469

△ Indicates safety critical components.

SPECIFICATIONS

● KDC-C469FM/FMA

Disc section

Laser Diode GaAlAs ($\lambda=780\text{nm}$)
Digital Filter 8 Times Over Sampling
D/A Converter 1 Bit
Spindle Speed 500rpm~200rpm (CLV)
Wow & Flutter Below Measurable Limit
Frequency Response 10Hz~20kHz ($\pm 1\text{dB}$)
Modulating Frequency ... 87.7MHz~89.9MHz (200kHz step)

General

Operating Voltage 14.4V (11V~16V)
Current Consumption 1.4A
Operating Temperature -10~50°C

Installation size

CD Changer 250 (W) x 64 (H) x 176 (D) mm
9-13/16 (W) x 2-1/2 (H) x 6-13/16 (D) inch
Remote controller Unit 43 (W) x 135 (H) x 22 (D) mm
1-11/16 (W) x 5-5/16 (H) x 7/8 (D) inch
Display Unit 105 (W) x 40 (H) x 18 (D) mm
4-1/8 (W) x 1-9/16 (H) x 11/16 (D) inch
Hide-away Unit 150 (W) x 30 (H) x 80 (D) mm
5-7/8 (W) x 1-3/16 (H) x 3-1/8 (D) inch

Weight

CD Changer 1.8kg (4.0lbs)
Remote controller Unit 0.05kg (0.12lbs)
Display Unit 0.125kg (0.28lbs)
Hide-away Unit 0.6kg (1.3lbs)

● KDC-C469/Y, C669/Y

Disc section

Laser Diode GaAlAs ($\lambda=780\text{nm}$)
Digital Filter 8 Times Over Sampling
D/A Converter 1 Bit
Spindle Speed 500rpm~200rpm (CLV)
Wow & Flutter Below Measurable Limit
Frequency Response 5Hz~20kHz ($\pm 1\text{dB}$)
Total Harmonic Distortion 0.005% (1kHz)
S/N Ratio 100dB
Dynamic Range 94dB
Channel Separation 96dB

General

Operating Voltage 14.4V (11V~16V)
Current Consumption 0.8A
Installation size 250 (W) x 64 (H) x 176 (D) mm
9-13/16 (W) x 2-1/2 (H) x 6-13/16 (D) inch
Weight 1.8kg (4.0lbs)

KENWOOD follows a policy of continuous advancements in development. For this reason specifications may be changed without notice.

KENWOOD CORPORATION

2967-3, Ishikawa-machi, Hachioji-shi, Tokyo 192-8525, Japan

KENWOOD USA CORPORATION
P.O. BOX 22745, 2201 East Dominguez Street, Long Beach, CA90801-5745, U.S.A.

KENWOOD ELECTRONICS CANADA INC.
6070 Kestrel Road, Mississauga, Ontario, Canada L5T 1S8

KENWOOD ELECTRONICS LATIN AMERICA S.A.
P.O. Box 55-2791 Paiteilla, Plaza Credicorp Bank Panama,
Piso 9, Oficina 901, Calle 50, Panama, Rep. de Panama

KENWOOD ELECTRONICS BRASIL LTDA.
Alameda Ministro Rocha Azevedo No. 456,
Edifício Jaú, 10o Andar, Cerqueira César, Cep 0140-001,
São Paulo-SP-Brasil

KENWOOD ELECTRONICS UK LIMITED
Kenwood House, Dwight Road, Watford, Herts, WD18 9EB, United Kingdom

KENWOOD ELECTRONICS DEUTSCHLAND GMBH
Rembrücker-Str. 15, 63150 Heusenstamm, Germany

KENWOOD ELECTRONICS FRANCE S.A.
13, Boulevard Ney, 75018 Paris, France

KENWOOD ELECTRONICS BELGIUM N.V.
Leuvensesteenweg 248 J, 1800 Vilvoorde, Belgium

KENWOOD ELECTRONICS ITALIA S.p.A.
Via G. Sirtori 7/9, 20129 Milano, Italy

KENWOOD IBÉRICA S.A.
Bolivia, 239-08020 Barcelona, Spain

KENWOOD ELECTRONICS AUSTRALIA PTY. LTD. (A.C.N. 001 499 074)
16 Giffnock Avenue, Centrecourt Estate, North Ryde,
N.S.W. 2113, Australia

KENWOOD ELECTRONICS (HONG KONG) LTD.
Unit 3712-3724, Level 37, Tower 1, Metroplaza, 223 Hing Fong Road, Kwai Fong, N.T.,
Hong Kong

KENWOOD ELECTRONICS GULF FZE
P.O. Box 61318, Jebel Ali, Dubai, U.A.E.

KENWOOD ELECTRONICS (THAILAND) CO., LTD.
2019 New Pechburi Road, Bangkok, Huaykwang, Bangkok, 10320 Thailand

KENWOOD ELECTRONICS SINGAPORE PTE. LTD.
1 Genting Lane, #07-00, Kenwood Building, Singapore, 349544

KENWOOD ELECTRONICS (MALAYSIA) SDN BHD
#4.01 Level 4, Wisma Academy Lot 4A, Jalan 19/1, 46300 Petaling Jaya, Selangor Darul Ehsan,
Malaysia